



TECHNICAL MANUAL



CPVC FIRE SPRINKLER PRODUCT

Installation Instructions
and Technical Handbook





© 2024 by IPEX Inc. All rights reserved. No part of this book may be used or reproduced in any manner whatsoever without prior written permission. For information contact: IPEX Management Inc. at 1383 North Service Road East, Oakville, Ontario, Canada, L6H 1A7.

The information contained here within is based on current information and product design at the time of publication and is subject to change without notification. IPEX does not guarantee or warranty the accuracy, suitability for particular applications, or results to be obtained therefrom.

INTRODUCTION 4

ADVANTAGES 5

TRAINING AND DEMONSTRATION 5

TRADEMARKS APPEARING IN THIS MANUAL 5

LISTINGS/APPROVALS (WHERE TO USE) 7

UNDERWRITERS LABORATORIES INC. (UL) AND UNDERWRITERS LABORATORIES INC. (C-UL) FOR USE IN CANADA 7

 Concealed Installations (UL) 7

 Concealed Installations (C-UL) 8

 Installation in Concrete (UL & C-UL) 8

 Exposed Installation - General (UL & C-UL) 10

 Smooth, Flat, Horizontal, Fixed Ceilings - Exposed Installations (UL & C-UL) 10

UNFINISHED BASEMENTS 12

 Exposed Installations 12

 Unfinished Basements with Solid Wood Joists OR Composite Wood Joists 12

 Open Web Joists 13

 Residential Dry Pipe Systems (UL) 17

 Low Pressure Dry Sprinkler Systems (UL) 18

 Air Plenums (UL) 19

 Garage Installations (UL) 19

 System Risers in NFPA 13, 13R and 13D Applications 19

 Underground Water Pressure Service (UL & C-UL) 21

 Outdoor Installations 24

FACTORY MUTUAL (FM) 24

 Concealed Installations (FM) 25

 Exposed Installations - Smooth, Flat, Horizontal Ceilings (FM) 25

 System Risers (FM) 26

 The Loss Prevention Council (LPCB) 27

ADDITIONAL APPROVALS 28

 NSF CERTIFIED 28

ORDINARY HAZARD INSTALLATIONS 28

TABLE OF CONTENTS

IPEX CPVC SPECIFICATIONS	31
Pipe	31
Fittings	32
Solvent Cement	32
PRODUCT RATINGS AND CAPABILITIES	32
Ambient Temperature and Heat Sources	32
Pressure Rating	32
Friction Loss	33
Thermal Expansion – U.S. Units	34
Thermal Expansion – Metric Units	36
PHYSICAL AND THERMAL PROPERTIES	47
Permissible Bending Deflections	47
SUPPORT AND HANGER REQUIREMENTS	52
Pipe Bracing with Standard Band Hanger	53
Hanger/Support Spacing	53
Vertical Restraint	54
Sway Bracing Guidance for CPVC	56
CHEMICAL COMPATIBILITY	57
PAINT	57
INSTALLATION	59
HANDLING & STORAGE OF IPEX CPVC	59
Handling – Pipe and Fittings	59
Storage – Pipe & Fittings	60
Handling – Solvent Cements	60
Storage – Solvent Cements	61
Solvent – Cement Spills	61
JOINING CPVC PIPE AND FITTINGS	
WITH ONE-STEP SOLVENT CEMENT	61
Apply Solvent Cement to Fitting	62
Deburring and Beveling Pipe End	62
Apply Solvent Cement to Pipe End	62
Assemble Pipe and Fitting	62
Estimating Cement Requirements	62
De-burring and Beveling	63

TABLE OF CONTENTS

Solvent Cement Application	63
Assembly	64
Set and Cure Times	65
System Acceptance Testing (Hydrostatic Pressure Test)	65
TFP-600 or BM-5 Solvent Cement Cure Times	66
Limited Pressurized Air or Nitrogen Testing Allowance	67
JOINING PIPE AND FITTINGS IN ADVERSE CONDITIONS	68
In Cold Weather	68
In Hot Weather	69
TRANSITION TO OTHER MATERIALS	69
Brass Threaded Connections	70
Sprinkler Installation in Rapid Seal Adapter (RSA) Fittings	70
Gasket Replacement in Rapid Seal Adapter (RSA) Fittings	71
Grooved Coupling Adapter Connections	72
PENETRATING FIRE RATED WALLS & PARTITIONS	72
FREEZE PROTECTION	73
Use of Dry Type Sprinklers	73
Use and Cautions with LFP® Antifreeze or Glycerin Antifreeze	73
Batt Insulation Requirements and Suggestions	74
Batt Insulation Installation Recommendations	75
CUT-IN PROCEDURE FOR SYSTEM MODIFICATION AND REPAIR	75
APPENDIX A – PIPE FITTINGS	80
APPENDIX B – DO’S & DON’TS	101
IMPORTANT INFORMATION WITH REGARDS TO YOUR IPEX CPVC FIRE SPRINKLER SYSTEM	103
NOTIFICATION TO JOBSITE BUILDING TRADES	104

INTRODUCTION

This Installation Handbook refers to IPEX CPVC Pipe and Fittings produced by IPEX USA LLC. IPEX CPVC Pipe and Fittings are produced using BLAZEMASTER compound. When reference to NFPA Standards is made in this Installation Handbook, the current edition of the relevant code is used. This Installation Handbook contains the criteria for installation (including system design, handling, and storage) of BLAZEMASTER piping systems in accordance with the applicable Listing/Approval agencies. Additionally, this handbook contains general piping practices and other installation suggestions that may not be required to satisfy the applicable Listing/Approval agencies. To differentiate between a requirement and a suggestion, use the following definitions:

SHALL or MUST – The use of the words “shall” or “must” indicates a mandatory requirement of the Listings/Approvals.

SHOULD or MAY – The use of the words “should” or “may” indicates a recommendation that is strongly advised, but not required to meet the Listings/Approvals.

This handbook is intended as a supplement to basic, fundamental knowledge relating to the installation and/or repair of CPVC fire sprinkler systems. Before commencing installation, a user should understand this Installation Handbook and confirm applicable National Fire Protection Association (NFPA) standards, the National Building Code of Canada (as applicable), and local approval and installation requirements for CPVC fire sprinkler systems.

NOTICE

The IPEX CPVC Pipe and Fittings described herein must be installed and maintained in compliance with this Installation Handbook and with the applicable standards of the National Fire Protection Association, in addition to the standards of any authorities having jurisdiction. Failure to do so may impair the performance of the IPEX CPVC Pipe and Fittings.

The owner is responsible for maintaining their fire protection system and devices in proper operating condition. The installing contractor or product manufacturer should be contacted with any questions.

It is the designer's responsibility to select products suitable for the intended service and to ensure that pressure ratings and performance data are not exceeded. Material selection should be verified to be compatible for the specific application. Designers and Installers must read and understand the installation instructions in this handbook.

Never remove any piping component or modify any piping deficiencies without first depressurizing and draining the system.

⚠ WARNING

Never use compressed air or nitrogen in lieu of or to replace the required hydrostatic system acceptance testing. Any pre-testing performed with low pressure air or nitrogen should follow the recommendations on Page 65. System failure when using high-pressure compressed air or nitrogen may result in property damage, serious injury, or death.

ADVANTAGES

IPEX CPVC Pipe and Fittings are designed specifically for fire sprinkler systems and provide the following advantages over traditional sprinkler piping systems:

- Increased hydraulic capabilities (C-Factor =150)
- No pre-cutting and expensive fabrication required
- Pipe, Slip Style Fittings and Rapid Seal Adapter (RSA) threaded sprinkler connection fittings – NSF-pw listed for use in pressure rated potable water piping systems
- Can easily be connected to other sprinkler piping systems
- Flexibility in the piping for greater ease of installation
- Resistant to rust, scale, and foreign contaminant build up
- Inexpensive tools required for installation
- Easily repaired or modified on site
- Easily transported and handled
- Resists sweating and condensation

TRAINING AND DEMONSTRATION

IPEX strongly recommends that installers receive hands on demonstration in the proper procedure(s) for installation of BlazeMaster fire sprinkler systems. On-site demonstration in proper pipe preparation, solvent cementing, proper handling of CPVC and installation instruction are available from IPEX at no charge. Upon completion of the BlazeMaster demonstration program, IPEX will issue a completion card to the persons successfully finishing the required subject matter. This card is to be carried when working on BlazeMaster systems. For information about on-site demonstration, contact your local IPEX sales representative.

TRADEMARKS APPEARING IN THIS MANUAL

IPEX	registered trademark of Aliaxis Group SA
BLAZEMASTER	registered trademark of The Lubrizol Corporation
CAULK AND WALK	registered trademark of The Lubrizol Corporation
SOFFI-STEEL	registered trademark of Grice Engineering
TEFLON	registered trademark of Dupont
OATEY	registered trademark of Oatey
GREAT WHITE	registered trademark of Oatey
IPS	registered trademark of IPS Corporation
CRISCO	registered trademark of J.M. Smucker Co.
FBC SYSTEM COMPATIBLE PROGRAM	registered trademark of The Lubrizol Corporation

IMPORTANT

Refer to Technical Data Sheet for warnings pertaining to regulatory and health information. TFP-600 and BM-5 One Step Solvent Cement are Listed for North America only.

LISTINGS/APPROVALS (WHERE TO USE)

For verification of Listings and Approvals, consult the current UL Fire Protection Equipment Directory, C-UL Products Certified for Canada Directory, Factory Mutual Research Approval Guide, or LPCB List of Approved Fire Security Products and Services Guide.

IPEX manufactures CPVC pipe and fittings using Lubrizol's BLAZEMASTER compound as a licensee of The Lubrizol Corporation.

UNDERWRITERS LABORATORIES INC. (UL) AND UNDERWRITERS LABORATORIES INC. (C-UL) FOR USE IN CANADA

IPEX CPVC Pipe and Fittings are UL and C-UL Listed for use in:

- Light Hazard and residential occupancies as defined in the Standard for Installation of Sprinkler Systems, NFPA 13
- Residential occupancies as defined in the Standard for the Installation of Sprinkler Systems in Low-Rise Residential Occupancies up to Four Stories in Height, NFPA 13R
- Residential occupancies as defined in the Standard for Installation of Sprinkler Systems in One and Two Family Dwellings and Manufactured Homes, NFPA 13D
- Air plenums, as defined by the Installation of Air Conditioning and Ventilating Systems, NFPA 90A
- Underground Water Pressure Service, NFPA 24
- System risers in accordance with NFPA 13, 13R, and 13D
- See UL Fire Protection Equipment Directory, categories VIWT and HFYH.
- See C-UL Products Certified for Canada Directory, categories VIWT7 and HFYH7.

IPEX fire sprinkler systems shall be employed in wet-pipe systems only. (A wet pipe system contains water or water and glycerin (anti-freeze solution) and is connected to a water supply so that the water or water and glycerin (anti-freeze solution) will discharge immediately when a sprinkler is opened.)

National Fire Protection Association Standards 13, 13R, 13D and NFPA 24, in addition to the standards of any other authorities having jurisdiction, must be referenced and followed for design and installation requirements in conjunction with this installation handbook.

Concealed Installations (UL)

- In accordance with the UL Listing, protection shall be provided for IPEX CPVC Pipe and Fittings. The minimum protection shall consist of either one layer of 3/8 in. (9,5 mm) thick gypsum wallboard, 1/2 in. (12,7 mm) plywood soffits, or a suspended membrane ceiling with lay-in panels or tiles having a weight of 0,35 pounds per sq ft (1,7 kg per sq m) when installed with metallic grids. For residential occupancies defined in NFPA 13D and 13R, the minimum protection may consist of one layer of 1/2 in. (12,7 mm) plywood.

Listed Quick Response, standard or extended coverage, 225°F

(107°C) maximum temperature rated sprinkler located in accordance with its Listing may be used.

Solvent cement joints shall be made with TFP-600 or BM-5 One Step Solvent Cement.

Concealed Installations (C-UL)

- In accordance with the C-UL Listing, protection shall be provided for IPEX CPVC Pipe and Fittings. The minimum protection shall consist of either one layer of 9,5 mm thick gypsum wallboard, one layer of 13 mm plywood, or a suspended membrane ceiling with lay-in panels or tiles classified with respect to surface burning characteristics having a mass of not less than 1,7 kg/m² when installed with metallic grids. The effectiveness of this protection can be impaired if penetrated by large openings such as ventilation grills, exhaust fans connected to metal ducts serving washrooms excepted. Where such penetration is present, individual openings exceeding 0,03 m² but not exceeding 0,71 m² in area must be located such that the distance from the edge of the opening to the nearest sprinkler does not exceed 300 mm.

In these cases any Quick or Standard Response, 107°C maximum temperature rated sprinkler or Listed Residential 107°C maximum temperature rated sprinkler located in accordance with its Listing may be used. IPEX CPVC Pipe and Fittings shall not be used where such openings exceed 0,71 m² in area.

Solvent cement joints shall be made with TFP-600 or BM-5 One Step Solvent Cement.

Installation in Concrete (UL & C-UL)

IPEX CPVC Pipe and Fittings are acceptable for use embedded in concrete. Direct contact with concrete does not have any adverse chemical effect on BLAZEMASTER materials. The following installation practices shall be followed.

- As the IPEX CPVC pipe is laid out it shall not come into contact with sharp objects or edges, such as rocks, metal, or structural members. Any open pipe ends shall be protected from debris or concrete getting into the system.
- When laying out IPEX CPVC pipe it is best to use straight runs of pipe. However, CPVC pipe is inherently ductile and it is possible for CPVC pipe to be snaked when it is laid out. This can be useful in some installations when some offset from a straight run can be helpful in avoiding various construction obstacles. Straight runs of pipe will minimize any stress that is exerted on the pipe. When the pipe is embedded in concrete there is not opportunity to relieve any stress once the concrete is poured. Therefore, it is important to layout the piping such that the stress is minimized from the time of installation. (Refer to Pipe Deflection section for allowable deflection.)
- Avoid the contact of IPEX CPVC Pipe and Fittings with construction materials that are incompatible with CPVC. Verify the suitability of a product for use with CPVC with the manufacturer of the chemical additive to confirm chemical compatibility.

BLAZEMASTER pipe and fittings have been successfully installed encased in concrete for many years. Lubrizol is unaware of any problems that have been caused by chemical incompatibility between BLAZEMASTER pipe and fittings and concrete or any chemicals that have been added to concrete. Since new construction materials are regularly introduced to the market, however, questions may arise regarding the compatibility of the products you're using. To help ensure a successful installation, Lubrizol recommends contacting the manufacturer of the chemical to confirm chemical compatibility.

- Steps must be taken to prevent the wire mesh or reinforcing bars from causing any abrasion damage to the IPEX CPVC Pipe and Fittings (see Handling and Storage section). This is mostly of concern prior to pouring the concrete. IPEX CPVC Pipe and Fittings shall not be installed directly within concrete that is to be post tensioned. The post tensioning process can create excessive forces which can damage the IPEX CPVC piping system. IPEX CPVC Pipe and Fittings may be installed within a sleeve or protective enclosure that is installed in concrete that is to be post tensioned provided the following conditions are met:
 - IPEX CPVC piping cannot be exposed to any stresses associated with post-tensioning concrete process.
 - IPEX CPVC piping cannot be exposed to, or be in direct contact with, any chemically incompatible materials.
 - IPEX CPVC piping shall have sufficient clearance to prevent direct contact to the sleeve. The system piping may rest on the bottom of the protective sleeve, provided linear movement of the system piping is not restricted.
 - The material of the sleeve or protective enclosure must be of sufficient strength so it does not compress on the IPEX CPVC system piping during the concrete pouring/tensioning process.
- When there are pipe joints that will be covered in concrete, the installation shall be pressure tested prior to pouring the concrete. If there will not be any joints covered by concrete, there is no need to pressure test the system prior to pouring the concrete.
- Prior to the pouring of the concrete, the IPEX CPVC pipe shall be intermittently secured to prevent movement during this process. Nonabrasive, plastic fasteners are good choices for this application. When hangers are used, most metal hangers designed for metal pipe are suitable for IPEX CPVC pipe. Do not use undersized hangers. Hangers with sufficient load bearing surface shall be selected based on pipe size (e.g., 1 1/2 in. hangers for 1 1/2 in. pipe). The hanger shall not apply compressive load or have rough or sharp edges that come into contact with the pipe.
- Care shall be taken so that the IPEX CPVC Pipe and Fittings are not damaged by the tools and equipment used to pour and finish the concrete. All standard methods of pouring concrete onto the ceiling construction with concrete pumps or concrete containers followed by compaction with vibrators can be used in combination with IPEX CPVC sprinkler systems. IPEX CPVC Pipe and Fittings shall not come into contact with equipment such as tampers and agitators.

- As the concrete is poured, assure that the pipe has not moved from its intended positioning.
- Thermal expansion and contraction is not an issue for IPEX CPVC Pipe and Fittings that are embedded in concrete. Those forces are relieved in a manner that does not affect the pipe or fittings. However, expansion and contraction shall be incorporated in the design of those sections of pipe that are not embedded in concrete. Failure to adequately allow for stress at these points may result in damage to the pipe where it enters and exits the concrete.

NOTE: *It is recommended that when transitioning from embedded to not embedded in concrete that 6 in. of 1 in. compatible foam pipe insulation be installed around the embedded pipe.*

Exposed Installation - General (UL & C-UL)

In accordance with the UL and C-UL Listings, IPEX CPVC Pipe and Fittings may be installed without protection (exposed), subject to the following additional limitations:

Note: *NFPA standards permit the omission of automatic sprinklers in areas such as small closets and bathrooms. Where sprinklers are not required, and when approved by the authority having jurisdiction, it is acceptable to install BLAZEMASTER products exposed in these areas.*

Note: *Where piping is required to be mounted directly to the ceiling/wall, the use of listed hangers for thermoplastic sprinkler piping mounted directly to the ceiling/wall is permitted. The resulting clearance between the pipe and the ceiling/wall as a function of using the listed hanger is acceptable.*

Smooth, Flat, Horizontal, Fixed Ceilings - Exposed Installations (UL & C-UL)

• Standard Coverage Sprinklers

- Pendent Sprinklers shall be Listed, Quick Response, 170°F (77°C) maximum temperature rated, sprinklers having deflectors installed within 8 in. (203,2 mm) of the ceiling. The maximum distance between sprinklers shall not exceed 15 ft (4,6 m). Piping shall be mounted directly to the ceiling.
- Upright Sprinklers shall be Listed, Quick Response, 155°F (68°C) maximum temperature rated, installed within 4 in. (101,6 mm) of the ceiling. The maximum distance between sprinklers shall not exceed 15 ft (4,6 m). The maximum distance from the ceiling to the centerline of the main run of pipe shall not exceed 7 1/2 in. (190,5 mm). The distance from the centerline of the sprinkler to the closest hanger shall be 3 in. (76,2 mm).
- Horizontal Sidewall Sprinklers shall be Listed, Quick Response, 200°F (93°C) maximum temperature rated, having deflectors within 12 in. (305,0 mm) of the ceiling and within 6 in. (152,4 mm) of the side wall. The maximum distance between sprinklers shall not exceed 14 ft (4,3 m). Piping shall be mounted directly to the side wall.
- Solvent cement joints shall be made with TFP-600 or BM-5 One Step Solvent Cement.

• Extended Coverage Sprinklers

- Pendent Sprinklers shall be Listed, Quick Response, 155°F (68°C) maximum temperature rated, having deflectors installed within 8 in. (203,2 mm) of the ceiling. The maximum distance between sprinklers shall not exceed 20 ft (6,1 m) with an application density of at least 0.1 gpm/sq ft (4,1 mm/min). Piping shall be mounted directly to the ceiling.
- Horizontal Sidewall Sprinklers shall be Listed, Quick Response, 165°F (74°C) maximum temperature rated, having deflectors within 12 in. (305,0 mm) of the ceiling and within 6 in. (152,4 mm) of the side wall. The maximum lateral distance between sprinklers shall not exceed 18 ft (5,5 m) with an application density of at least 0.1 gpm/ft² (4,1 mm/min). Piping shall be mounted directly to the side wall.
- Horizontal Sidewall Sprinklers shall be Listed, Quick Response, 175°F (79°C) maximum temperature rated, having deflectors within 12 in. (305,0 mm) of the ceiling and within 6 in. (152,4 mm) of the side wall. The maximum lateral distance between sprinklers shall not exceed 16 ft (4,9 m) with an application density of at least 0.1 gpm/ft² (4,1 mm/min). Piping shall be mounted directly to the side wall.
- When using fittings 1 1/2 in. (DN40) and larger only Schedule 80 fittings may be used.
- Solvent cement joints shall be made with TFP-600 or BM-5 One Step Solvent Cement.

• Residential Sprinklers

- Pendent Sprinklers when the maximum lateral distance between sprinklers is 15 ft (4,6 m) or less. Sprinklers shall be Listed 170°F (77°C) maximum temperature rated, having deflectors located in accordance with their Listing and not exceeding 8 in. (203,2 mm) from ceiling. The demand for the sprinklers shall be the minimum flow rates indicated in individual listing. Piping shall be mounted directly to the ceiling.
- Pendent Sprinklers when the maximum lateral distance between sprinklers exceeds 15 ft (4,6 m) but does not exceed 20 ft (6,1 m). Sprinklers shall be Listed 155°F (68°C) maximum temperature rated, having deflectors located in accordance with their Listing and not exceeding 8 in. (203,2 mm) from ceiling. The demand for the sprinklers shall be the greater of either the minimum flow rates indicated in individual listing or calculated based on delivering a minimum of 0.1 gpm/sq ft (4,1 mm/min) over the design area in accordance with the provisions of NFPA 13:(2007) Section 11.3.1.2. Piping shall be mounted directly to the ceiling.
- Horizontal Sidewall Sprinklers when the maximum lateral distance between sprinklers is 14 ft (4,3 m) or less. Sprinklers shall be Listed 200°F (93°C) maximum temperature rated having deflectors located in accordance with their Listing. The demand for the sprinklers shall be the minimum flow rates indicated in individual listing. Piping shall be mounted directly to the side wall.
- Horizontal Sidewall Sprinklers when the maximum lateral distance between sprinklers exceeds 14 ft (4,3 m) but does not exceed 18 ft (5,5 m). Sprinklers shall be Listed 165°F (74°C) maximum temperature rated having deflectors 12 in. (305,0 mm) from ceiling and within 6 in. (152,4 mm) of the wall. The demand for the sprinklers shall be the greater

of the minimum flow rates indicated in individual listing or calculated based on delivering a minimum of 0.1 gpm/sq ft (4,1 mm/min) over the design area in accordance with the provisions of NFPA 13:(2007) Section 11.3.1.2. The maximum sprinkler area of coverage shall not exceed 18 ft x 18 ft (5,5 m x 5,5 m). Piping shall be mounted directly to the side wall.

- When applying criteria having a minimum 0.1 gpm/sq ft (4,1 mm/min), Schedule 80 fittings must be used when sizes are 1 1/2 in. (DN40) and larger.
- Solvent cement joints shall be made with TFP-600 or BM-5 One Step Solvent Cement.

UNFINISHED BASEMENTS

Exposed Installations

BLAZEMASTER CPVC pipe and fittings may be installed without protection (exposed) in unfinished basements in accordance with NFPA 13D when subject to the following additional limitations:

Unfinished Basements with Solid Wood Joists OR Composite Wood Joists

- The ceiling shall be horizontal and constructed utilizing solid wood joists or composite wood joists with a nominal depth of 16 in. (406,4 mm) or less on maximum 24 in. (609,6 mm) centers.
- The distance from the floor to the bottom of the joists shall be between 7 ft and 10 ft (2,1 m and 3,0 m).
- Listed residential pendent sprinklers with a maximum temperature rating of 155°F (68°C) and a minimum K-factor of 4.9 are to be used for this type of installation. The maximum sprinkler spacing shall not exceed 16 ft (4,9 m). Lesser areas are also permitted. The system is to be designed based upon the Listed flows for the sprinkler selected except that the flow for a single sprinkler or for multiple sprinklers flowing is to be not less than 13 gpm (49,2 lpm) per sprinkler. The sprinklers are to be installed with their deflectors a maximum of 1 3/4 in. below the bottom of the solid wood or composite wood joists in anticipation of future installation of a finished ceiling. (Refer to NFPA 13D, Section 8.2.4, 2016 Edition.)
- Schedule 80 fittings in the 1 1/2 in. and larger sizes shall be used.
- All solvent cement joints shall be made with One Step Solvent Cement (TFP-600 or BM-5).
- The maximum length along the joist shall not exceed 40 ft (12,2 m). When the length exceeds 40 ft (12,2 m), blocking shall be utilized. The blocking shall be constructed of minimum 1/2 in. (12,7 mm) plywood, minimum 3/8 in. (9,5 mm) gypsum wallboard or batt insulation with a minimum thickness of 3 1/2 in. (89 mm). These blocking materials shall be the full depth of the joists. When batt insulation is used as blocking, it must be a single piece of insulation. The insulation must be secured in place with metal wire netting which must encase the insulation on both of the exposed sides. The metal wire netting is required to hold the insulation in place and prevent it from being dislodged or repositioned over time. It is acceptable for items such as piping, wires, ducts, etc.

Figure 1 - Unfinished Basement, Solid Wood Joists, Center Wall Riser with Center Room Main

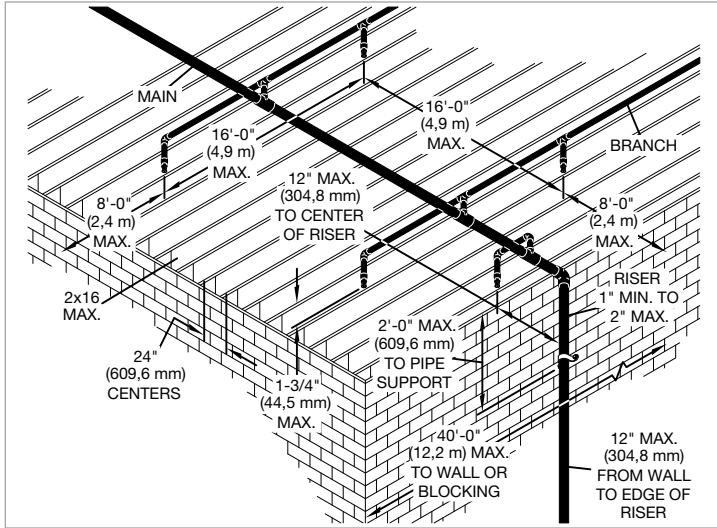

Figure 2 - Unfinished Basement, Solid Wood Joists, Center Wall Riser with Main at Wall

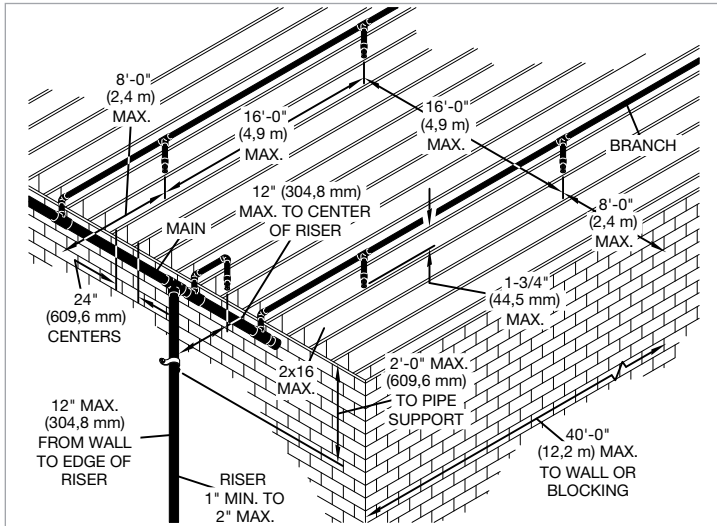

Figure 3 - Unfinished Basement, Solid Wood Joists, Riser in Corner

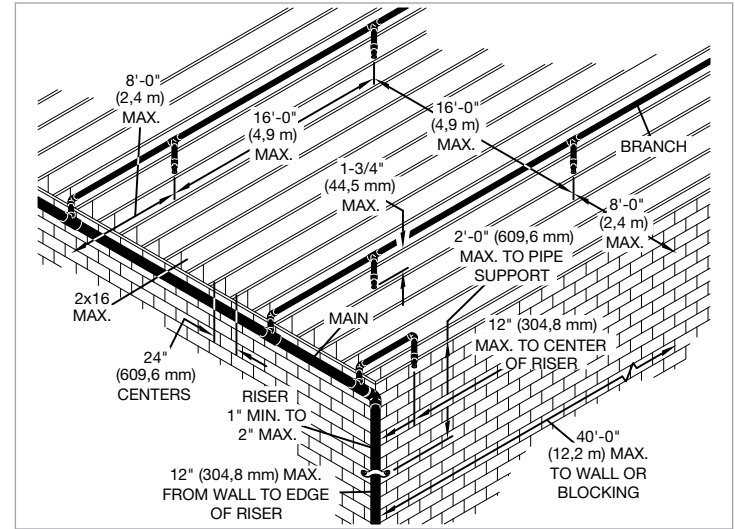

Figure 4 - Unfinished Basement, Solid Wood Joists, Blocking

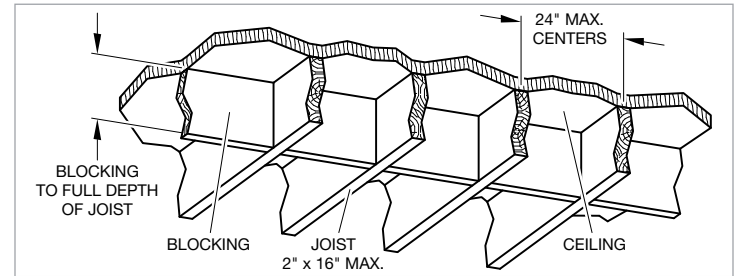
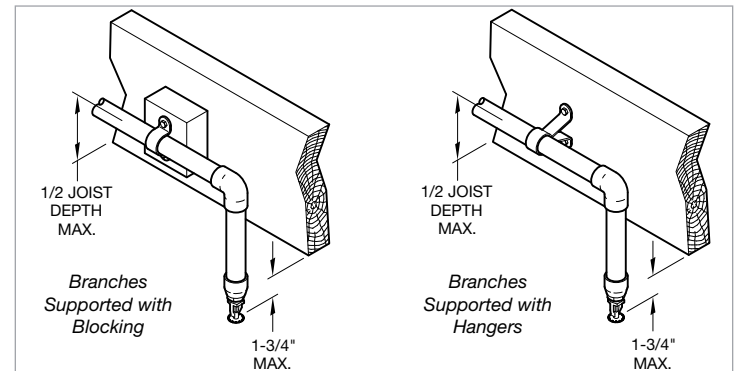

Figure 5 - Unfinished Basement, Branch Line Support



- Listed quick response horizontal sidewall sprinklers with a maximum temperature rating of 155°F (68°C) and a minimum K-factor of 4.2 installed below the joists. The sprinklers are to be installed with their deflectors a maximum of 4 1/2 in. (115 mm) below the bottom of the joists in anticipation of future installation of a finished ceiling (reference NFPA 13D). The residential horizontal sidewall sprinklers deflectors shall be located within the maximum distance from the wall as specified in their listing, but in no case more than 7 in. (178 mm) from the face of the wall or soffit on which they are mounted.

The maximum distance between sprinklers shall not exceed 14 ft (4,26 m). A sprinkler shall be located not more than 5 ft (1,5 m) from all corners. Lesser spacings are permitted based on limitations of the sprinklers. The system is to be designed based upon the Listed flows for the sprinkler selected except that the flow for a single sprinkler or for multiple sprinklers flowing is to be not less than 14 gpm (53 lpm) per sprinkler, and a discharge density not less than 0.07 gpm per ft² (0,12 lpm per m²).

- The system shall be installed as a loop in each space being protected. Schedule 80 fittings shall be used for sizes 1 1/2 in. and larger.
- All solvent cement joints shall be made with One Step Solvent Cement (TFP-600 or BM-5).
- The protected area of an individual space shall not be greater than 1,792 ft² (127.5 m²), with a maximum width of 32 ft (7,5 m) and a maximum length of 56 ft (17 m).
- The piping shall be mounted directly to the wall using listed support devices for thermoplastic sprinkler piping or other listed support devices either below the joist bay to a maximum of 4 1/2 in. (115 mm) below the bottom of the joist, or piping shall be run in the joist bay with drops to the sidewall sprinkler.

Combustible Concealed Spaces (UL)

IPEX CPVC Pipe and Fittings are not approved for installation in combustible concealed spaces requiring sprinklers, as referenced in NFPA 13 unless protected by sprinklers specifically Listed for this application. Although NFPA 13R and 13D permit the omission of sprinklers from combustible concealed spaces, IPEX CPVC Pipe and Fittings can be installed in these areas when protecting residential occupancies according to these standards.

For installations where sprinkler pipe runs through an attic space that requires sprinklers per NFPA, CPVC piping shall be protected in order to meet the requirements of its UL and C-UL Listings. Additionally, the authority having jurisdiction shall be consulted prior to any installation of CPVC in attic spaces requiring sprinklers. Protection methods and requirements may vary by jurisdiction and are subject to interpretation.

- Special Use Sprinklers – Specific Application Attic Sprinklers
 - Product Description – In accordance with the UL Listing, Specific Application Sprinklers for Protecting Attics are designed to provide protection of specific light hazard combustible, as well as noncombustible, attic spaces requiring sprinkler protection. The

Specific Application Sprinklers for Protecting Attics allow for the use of IPEX CPVC Pipe and Fittings within the attic space and to supply the wet system sprinklers below the ceiling provided the attic space is protected with Specific Application Sprinklers for Protecting Attics.

- Installation Requirements – When using the Specific Application Sprinklers for protecting attics, reference Sprinkler manufacturer technical data sheets..
- Special Use Sprinklers
 - Product Description – In accordance with the UL Listing, the IPEX Specific Application Combustible Concealed Space Sprinklers are specific application sprinklers designed to provide protection of specific light hazard combustible, as well as noncombustible, concealed spaces requiring sprinkler protection. Sprinklers in some cases allow for the use of IPEX CPVC Pipe and Fittings within concealed spaces requiring automatic sprinkler protection.

Residential Dry Pipe Systems (UL)

In accordance with the Underwriters Laboratories Inc. (UL) Listing, IPEX CPVC Fire Sprinkler Pipe and Fittings made with BLAZEMASTER compound may be installed in Dry Pipe Systems for Residential Occupancies when subject to the additional limitations listed in this section.

- Acceptable Residential Occupancies are defined as follows:
 - Concealed (protected) installations in residential sprinkler systems for one- and two- family dwellings and manufactured homes per NFPA 13D.
 - Residential sprinkler systems for residential occupancies up to and including four stories in height per NFPA 13R.
 - Residential portions of any occupancy per NFPA 13 where calculations for Dry Pipe System water delivery are based on the hazard shown in Table A using a calculation program listed by a nationally recognized laboratory or obtained where the system design specifies that water is delivered to the system test connection in not more than 15 seconds for Residential Occupancies, starting at normal air pressure on the system.
- Residential sprinklers used in conjunction with IPEX CPVC Fire Sprinkler Pipe and Fittings in Dry Pipe Systems shall be specifically listed for such use.
- The IPEX CPVC Sprinkler Head Adapter Tee (P/N 48159) is to be used with dry-type residential pendent sprinklers in dry pipe system installations.
- Dry Pipe Systems in areas subject to freezing shall be pitched at least 1/4 in. or 1/2 in. per 10 ft (2 mm/m) in accordance with the appropriate NFPA standard being utilized.
- Upon completion of the assembly and cure, the system shall be hydrostatically tested in accordance with the procedures described in the CPVC Installation Handbook.

- IPEX CPVC Fire Sprinkler pipe and fittings used in Dry Pipe Systems may not be used in combination with other thermoplastic piping systems unless specifically listed for use in Dry Pipe Systems. Combining with steel or copper piping systems is permitted, where applicable.
- The pipe and fittings shall be protected (concealed) in accordance with the specifications outlined in the CPVC Installation Handbook (IH-1900).
- Exposed pipe and fittings have not been evaluated.
- Minimum use temperature shall be -20°F (-29°C).
- 3/4 in. to 3 in. pipe and fittings are listed for these applications and are to be assembled with TFP-600 or BM-5 One Step Solvent Cement.
- In-service system Air Pressure shall be maintained at a maximum of 15 psi (1 bar).
- Pipe friction loss shall be calculated in accordance with the Hazen-Williams formula using a C value of 150.
- Air supply to the IPEX CPVC Pipe and Fittings shall be free of oil and oil vapor. Automatic air compressors shall be of an oil-less type or the air shall be treated to assure oil or oil vapor is not introduced into the piping

Table A
Residential Dry Pipe System Water Delivery

Hazard	Residential	Light
Number of Most Remote Sprinklers Initially Open	1	1
Maximum Time of Water Delivery	15 Seconds	60 seconds

Low Pressure Dry Sprinkler Systems (UL)

IPEX BLAZEMASTER pipe is Listed by UL for use in dry pipe sprinkler systems with the following characteristics:

- Pressure does not exceed 15 psi (1,03 bar)
- Ambient temperature is above -20°F (-28,9°C)

The dry system must be installed in Light Hazard and Residential occupancies in accordance with NFPA 13D, NFPA 13R, and/or NFPA 13.

When air is used in dry pipe sprinkler systems that utilize IPEX BLAZEMASTER CPVC pipe and fittings, there must be no residual oil in the compressed air. The types of oil used in this application may be incompatible with CPVC. If the oil is not removed from the compressed air, there is the risk that the oil may be incompatible with CPVC. Check the BLAZEMASTER website for chemical compatibility.

The dry pipe sprinkler system must be designed to provide pressure relief when the system pressure exceeds 15 psi (1,03 bar). As an alternative to this requirement, the system may be equipped with an alarm that sounds when the pressure exceeds 15 psi (1,03 bar).

Air Plenums (UL)

IPEX CPVC Pipe and Fittings are UL Listed for use in air plenums. IPEX CPVC Pipe and Fittings comply with UL1887 combustibility requirements for thermoplastic sprinkler pipe as described in the Standard for Installation of Air Conditioning and Ventilating Systems, NFPA 90A, and various model mechanical codes. IPEX CPVC Pipe and Fittings may be installed in the plenum adjacent to, but not over, an opening in the ceiling such as ventilation grills. Return Air Plenum installations may only be made with UL Listed IPEX CPVC Pipe and Fittings and require the use of Schedule 80 fittings when sizes are 1-1/2 in. (DN40) and larger.

Garage Installations (UL)

Garage Installation Specifications shall only apply for the installation of UL Listed IPEX CPVC Pipe and Fittings in garages requiring sprinkler protection per NFPA 13D and NFPA 13R. These Standards are defined in NFPA codes entitled "One and Two Family Dwellings and Mobile Homes" and in "Residential Occupancies up to Four Stories in Height". As referenced in NFPA 13D:(2007) Section 8.6.4, "Sprinklers are not required in garages, open attached porches, carports or similar structures." The installation of IPEX CPVC Pipe and Fittings for use in garages requiring sprinkler protection per NFPA 13R is only applicable to the UL Listing of this product.

Requirements for Pipe, Fittings, Solvent Cement Systems, System Design, Installation, Freeze Protection, and Penetrating Fire Related Walls and Partitions are covered in this Installation Handbook. Read these sections carefully prior to designing or installing IPEX CPVC Pipe and Fittings for garage installations.

• Installation Requirements

- Protection: IPEX CPVC Pipe and Fittings shall be installed concealed behind protection consisting of a minimum of one layer of 3/8 in. (9,5 mm) thick gypsum wallboard or 1/2 in. (13 mm) thick plywood.
- Sprinkler Requirements: UL Listed, pendent or sidewall sprinklers with a 225°F (107°C) maximum temperature rating shall be utilized. All sprinklers shall be installed per the manufacturer's published installation instructions.
- Installation Standard: The Listing for Garage Installations shall pertain to those occupancies defined by NFPA 13R.

System Risers in NFPA 13, 13R and 13D Applications

BLAZEMASTER pipe and fittings may be used as system risers in accordance with NFPA 13, 13D and 13R when subject to the following limitations:

1. When installed protected (concealed), the minimum protection shall consist of either one layer of 3/8" (9.5 mm) thick gypsum wallboard or 1/2" (12.7 mm) thick plywood.
2. When installed without protection (exposed), the following limitations shall apply:

Note: Only NFPA 13R and 13D applications may be installed without protection exposed).

- a. The riser shall be installed below a smooth, flat, horizontal ceiling construction. A Listed residential pendent sprinkler is to be installed with its deflector at the distance from the ceiling specified in the sprinkler Listing.

OR

The riser shall be installed below a horizontal unfinished basement ceiling (in accordance with NFPA 13D) constructed utilizing solid wood joists, composite wood joists, open wood joists OR open steel joists with a nominal depth of 16" (406 mm) or less on maximum 24" (610 mm) centers.

Listed residential pendent sprinkler is to be installed with its deflector a maximum of 1 3/4" (44.5 mm) below the bottom of the joist in anticipation of future installation of a finished ceiling.

- b. A Listed residential pendent sprinkler is to have a maximum temperature rating of 155°F and a minimum K-factor of 4.9 and is to be installed at a maximum horizontal distance of 12 inches from the centerline of the riser and a maximum horizontal distance of 15 inches from the wall. The system is to be designed based upon the Listed flows for the sprinkler selected except that the flow for a single sprinkler or for multiple sprinklers flowing is to be not less than 13 gpm per sprinkler.
- c. The riser shall be supported vertically within 2 feet of the ceiling or bottom of the joist.
- d. The minimum riser diameter shall be 1 in. and the maximum riser diameter shall be 2 in.
- e. The maximum distance between the wall and the outside surface of the riser pipe shall be 12 in.
- f. All solvent cement joints shall be made with One Step Solvent Cement (TFP-600 or BM-5).
- g. The instructions shown here for Exposed System Risers require the use of Schedule 80 fittings when riser sizes are 1 1/2" (38 mm) and larger.
3. The system shall be installed per the requirements of NFPA 13 Section 9.2.5(2016 Edition), Support of Risers.
4. IPEX CPVC Pipe and Fittings shall be installed per the manufacturer's Installation Instruction and Technical Handbook.
5. Risers shall be supported by pipe clamps or by hangers located on the horizontal connection closest to the riser. Only Listed hangers and clamps shall be used.
6. Vertical lines must be supported at intervals, described in Paragraphs 9 and 10 below to avoid placing excessive load on a fitting at the lower end. Do this by using riser clamps or double bolt pipe clamps Listed for this service. The clamps must not exert compressive stresses on the pipe. If possible, the clamps should be located just below a fitting so that the shoulder of the fitting rests against the clamp. If necessary, a coupling can be modified and adhered to the pipe as a bearing support (modified riser collar) such that the shoulder of the fitting rests on the clamp (Ref. Figure 6). Follow the cure times in Tables U, V, and W.

Note: A modified riser collar shall only be used to provide support to the riser and shall not be used to join two pieces of pipe.

7. Do not use riser clamps that squeeze the pipe and depend on compression of the pipe to support the weight.
8. Hangers and straps shall not compress, distort, cut or abrade the piping and shall allow for free movement of the pipe to permit thermal expansion and contraction. The pipe can be damaged, and compression increases the likelihood of stress cracking.
9. Maintain vertical piping in straight alignment with supports at each floor level, or at 10 ft (3,1 m) intervals, whichever is less.
10. IPEX CPVC risers in vertical shafts or in buildings with ceilings over 25 ft (7,6 m), shall be aligned straightly and supported at each floor level, or at 10 ft (3,1 m) intervals, whichever is less.

Figure 6 – Riser Collar

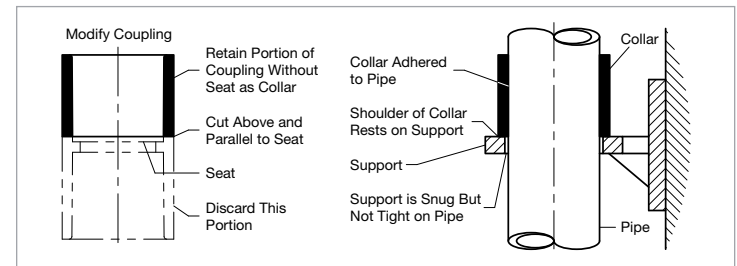

Underground Water Pressure Service (UL & C-UL)

- Pipe – IPEX CPVC Pipe complies with the requirements of ASTM F442 and standard dimension ratio (SDR) 13.5. IPEX pipe is UL Listed and C-UL Listed for a rated pressure of 175 psi (12,1 bar) for underground service.
- Fittings – IPEX CPVC Fittings comply with the requirements of ASTM F438 (Schedule 40 socket), ASTM F439 (Schedule 80 socket) and ASTM F1970 (Transition fittings).
- Solvent Cement – All socket type joints shall be made in accordance with IPEX's Installation Instructions using the TFP-600 or BM-5 One Step Solvent Cement.

Note: When using IPEX CPVC Pipe and Fittings, installation must be in accordance with ASTM D2774, the standard recommended practice for underground installation of thermoplastic pressure piping and ASTM F645, the standard guide for selection, design, and installation of thermoplastic water pressure piping systems, and all IPEX installation instructions contained within this Technical Manual.

- System Design – An IPEX CPVC underground system shall be hydraulically calculated using a Hazen-Williams C-Factor of 150, and designed and installed in accordance with the "Installation of Sprinkler Systems," NFPA 13, 2007 edition, and where appropriate the "Standard for Installation of Private Fire Service Mains and Their Appurtenances," NFPA 24.

- Installation Procedures - The installation procedures detailed within apply to IPEX CPVC Pipe that has solvent cemented joints in sizes ranging from 3/4 in. to 3 in. (DN20 to DN80).
- Inspection - Before installation, IPEX CPVC Pipe and Fittings should be thoroughly inspected for cuts, scratches, gouges, or split ends. Discard damaged pipe.
- Trenching - The trench should be of adequate width to allow convenient installation, while at the same time being as narrow as possible. Minimum trench widths may be utilized by joining pipe outside of the trench and lowering it into the trench after adequate joint strength has been achieved.

Note: Refer to IPEX's instructions for recommended set and cure times for solvent cemented joints as found in Tables U, V, and W. Where pipe is joined in the trench, or where thermal expansion and contraction are factors, trench widths may have to be widened. For additional details on expansion and contraction, see thermal expansion characteristics in Tables H1 and H2. Table B shows the trench width and minimum ground cover required for underground installation.

All IPEX CPVC Pipe that is water filled should be buried at least 12 in. (304,8 mm) below the maximum expected frost line. It is recommended that IPEX piping be run within a metal or concrete casing when it is installed beneath surfaces that are subject to heavy-weight or constant traffic such as roadways and railroad tracks.

The trench bottom should be continuous, relatively smooth and free of rocks. Where ledge rock, hardpan or boulders are encountered, it is necessary to pad the trench bottom using a minimum of 4 in. (102,0 mm) of tamped earth or sand beneath the pipe as a cushion and to protect the pipe from damage. Sufficient cover must be maintained to keep external stress levels below maximum design stress. Reliability and safety of service is of major importance in determining minimum cover. Local, state and national codes may also govern.

- Maintenance - Maintenance of IPEX CPVC Pipe and Fittings for underground water service shall be in accordance with the Standard for Inspection, Testing and Maintenance of Water Based Extinguishing Systems as defined by NFPA 25.
- Snaking of Pipe - After IPEX CPVC pipe has been solvent cemented, it is advisable to snake the pipe according to the following recommendations beside the trench during its required drying time. BE ESPECIALLY CAREFUL NOT TO APPLY ANY STRESS THAT WILL DISTURB THE UNDRIED JOINT. Snaking is necessary to allow for any anticipated thermal contraction that will take place in the newly joined pipe line. Snaking is particularly necessary on the lengths of pipe that have been solvent cemented during the afternoon hours of a hot summer day because the drying time will extend through the cool of the night when thermal contraction of the pipe could stress the joints to the point of pull out. This snaking is also especially necessary with pipe that is laid in its trench (necessitating wider trenches than recommended) and is back-filled with cool earth before the joints are thoroughly dry. Tables C1 and C2 show the Pipe Snaking and the Loop Offset dimensions to compensate for contraction.

Table B - Ground Cover

Nominal Pipe Size ANSI DN	Trench Width		Ground Cover Minimum			
			Light Traffic		Heavy Traffic	
in	in	mm	in	mm	in	mm
3 DN80 & Under	8	203,2	12 - 18	305,0 - 457,2	30 - 36	762,0 - 914,4

Table C1 - U.S. Units
Maximum Temperature Variation, °F
Between Time of Solvent Welding and Final Use

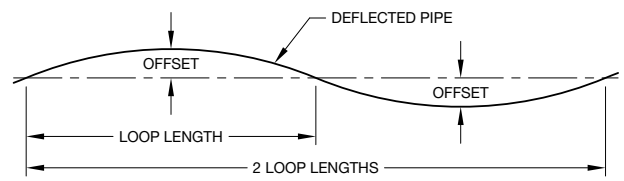

Loop Length Feet	Temperature Variation, °F									
	10°	20°	30°	40°	50°	60°	70°	80°	90°	100°
	Offset- Inches									
20	3	4	5	5	6	6	7	7	8	8
50	7	9	11	13	14	16	17	18	19	20
100	18	18	22	26	29	32	35	37	40	42

Table C2 - Metric Units
Maximum Temperature Variation, °C
Between Time of Solvent Welding and Final Use

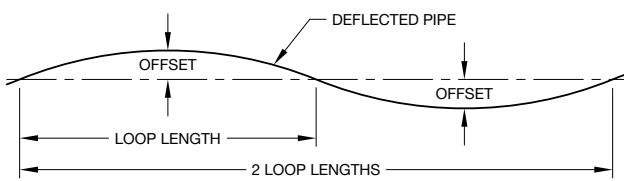

Loop Length Meters	Temperature Variation, °C									
	5°	10°	15°	20°	25°	30°	35°	40°	45°	50°
	Offset- Millimeters									
5	65	83	95	105	114	123	133	143	154	164
15	164	219	266	307	343	377	409	440	469	498
30	314	424	522	609	687	758	823	884	943	999

- Back-Filling – Ideally, back-filling should only be done early in the morning during hot weather when the line is fully contracted so that there is no chance of insufficiently dried joints being subject to contraction stresses.

The pipe should be uniformly and continuously supported over its entire length with firm, stable material. Blocking should not be used to change pipe grade or to intermittently support pipe across excavated sections. Pipe is installed in a wide range of sub soils. These soils should not only be stable, but applied in such a manner so as to physically shield the pipe from damage. Attention should be given to local pipe laying experience that may indicate particular bedding problems.

Back-filled material free of rocks with a size of 1/2 in. (12,7 mm) or less should be used to surround the pipe with 6 in. to 8 in. (152,4 mm to 203,2 mm) of cover. The back-filled material should be placed in layers. Each soil layer should be sufficiently compacted uniformly to develop laterally passive soil forces during the back-fill operation. It may be advisable to have the pipe under water pressure, 15-25 psi (1,0-1,7 bar) during the back-filling.

Vibratory methods are preferred when compacting sand or gravel. Best results are obtained when the soils are in a nearly saturated condition. Where water flooding is used, the initial back-fill should be sufficient to ensure complete coverage of the pipe. Additional material should not be added until the water flooded back-fill is firm enough to walk on. Care should be taken to avoid floating the pipe.

Sand and gravel containing a significant portion of fine-grained material such as silt and clay should be compacted by hand or preferably by a mechanical tamper. The remainder of the back-fill should be placed and spread in uniform layers in such a manner as to fill the trench completely so that there will be no unfilled spaces under or about rocks or lumps of earth in the back-fill. Large or sharp rocks, frozen clods and other debris greater than 3 in. (76,2 mm) in diameter should be removed. Rolling equipment or heavy tampers should only be used to consolidate the final back-fill.

Outdoor Installations

IPEX CPVC Pipe and Fittings are not listed for outdoor applications other than underground.

FACTORY MUTUAL (FM)

IPEX CPVC Pipe and Fittings are FM Approved for use in:

- Miscellaneous non-manufacturing occupancies as described in FM Loss Prevention Data Sheet 3-26, "Fire Protection Water Demand for Non-storage Sprinklered Properties", Table 2, Section L.
- Residential occupancies as described in FM Loss Prevention Data Sheet 3-26, "Installation of Sprinkler Systems".

IPEX Fire Sprinkler Systems shall be employed in wet pipe systems only. (A wet pipe system contains water or water and glycerin [anti-freeze solution] and is connected to a water supply so that the water or water and glycerin [anti-freeze solution] will discharge immediately when the sprinkler is opened.)

Concealed Installations (FM)

In accordance with the FM Approval, protection shall be provided for IPEX CPVC Pipe and Fittings as follows:

- The minimum protection shall consist of either a permanently installed noncombustible barrier from any area protected by the system.

Note: *A permanently installed barrier is one that cannot be removed without substantial cosmetic damage. Drop ceiling tiles, as used in suspended ceilings are specifically considered not be permanently installed for the purposes of this definition. Noncombustible is defined as having a minimum finish fire rating of 15 minutes when tested per ASTM E119.*

- As an alternative to the protection of a permanently installed noncombustible barrier, FM has approved the use of IPEX CPVC with the SOFFI-STEEL™ covering system manufactured by Grice Engineering.
- FM Approved quick response, standard or extended coverage, or FM Approved residential sprinklers installed in accordance with their approval limitations may be used.
- Solvent cement joints shall be made with TFP-600 or BM-5 One Step Solvent Cement.

Exposed Installations – Smooth, Flat, Horizontal Ceilings (FM)

In accordance with the FM Approval, IPEX CPVC Pipe and Fittings may be installed without protection (exposed), subject to the following additional limitations:

Note: *Where piping is installed above drop ceiling tiles, the piping shall be considered exposed.*

Ceilings may be combustible, or non permanently installed.

• Standard Coverage Sprinklers

- Pendent sprinklers shall be FM Approved, quick response sprinklers having deflectors installed within 8 in. (203,2 mm) of the ceiling. The maximum distance between sprinklers shall not exceed 15 ft (4,6 m). The maximum ceiling height shall not exceed 10 ft (3,0 m).
- Upright sprinklers shall be FM Approved, quick response sprinklers having deflectors installed within 4 in. (101,6 mm) of the ceiling. The maximum distance between sprinklers shall not exceed 15 ft (4,6 m). The maximum distance from the ceiling to the centerline of the main run of pipe shall not exceed 7-1/2 in. (191 mm). The distance from the centerline of the sprinkler to the closest hanger shall be 3 in. (76,2 mm). The maximum ceiling height shall not exceed 10 ft (3,0 m).
- Horizontal Sidewall Sprinklers shall be FM Approved, quick response sprinklers having deflectors installed within 12 in. (304,8 mm) of the ceiling and within 6 in. (152,4 mm) of the side wall. The maximum distance between sprinklers shall not exceed 14 ft (4,3 m). The maximum ceiling height shall not exceed 10 ft (3,0 m).
- Solvent cement joints shall be made with TFP-600 or BM-5 One Step Solvent Cement.

• Extended Coverage Sprinklers

- Pendent sprinklers shall be FM Approved, quick response sprinklers having deflectors installed within 8 in. (203,2 mm) of the ceiling. The maximum distance between sprinklers shall not exceed 20 ft (6,1 m). When the sprinklers are not on square spacings, the flow for a sprinkler should be based on the density applied over the square area calculated for the largest dimension of the sprinkler spacing. The maximum ceiling height shall not exceed 10 ft (3,0 m).
- Horizontal Sidewall Sprinklers shall be FM Approved, quick response sprinklers having deflectors installed within 12 in. (304,8 mm) of the ceiling and within 6 in. (152,4 mm) of the side wall. The maximum lateral distance between sprinklers shall not exceed 16 ft (4,9 m). The maximum ceiling height shall not exceed 10 ft (3,0 m).
- The minimum flow or pressure established for Extended Coverage Systems shall be per FM Loss Prevention Data Sheet 2-0 and 3-26.
- Solvent cement joints shall be made with TFP-600 or BM-5 One Step Solvent Cement.

• Residential Sprinklers

- Pendent sprinklers shall be FM Approved, residential sprinklers having deflectors installed within 8 in. (203,2 mm) of the ceiling. The maximum distance between sprinklers shall not exceed 20 ft (6,1 m). The minimum required discharge from each sprinkler is to be the greater of either the approved flow rate applied over the square area calculated for the largest dimension of the sprinkler spacing or a minimum discharge of 0.1 gpm/sq ft (4,1 mm/min) over the actual area (S x L) covered by the sprinkler. The maximum ceiling height shall not exceed 10 ft (3,0 m).
- Horizontal Sidewall Sprinklers shall be FM Approved, quick response sprinklers having deflectors installed within 12 in. (304,8 mm) of the ceiling and within 6 in. (152,4 mm) of the side wall. The maximum lateral distance between sprinklers shall not exceed 16 ft (4,9 m). The minimum required discharge from each sprinkler is to be the greater of either the approved flow rate applied over the area calculated for the largest dimension of the sprinkler spacing or a minimum discharge of 0.1 gpm/sq ft (4,1 mm/min) over the actual area (S x L) covered by the sprinkler. The maximum ceiling height shall not exceed 10 ft (3,0 m).
- The minimum flow or pressure established for Residential Sprinkler Systems shall be per FM Loss Prevention Data Sheet 2-0 and 3-26.
- Solvent cement joints shall be made with TFP-600 or BM-5 One Step Solvent Cement.

System Risers (FM)

In accordance with the FM Approval, IPEX CPVC Pipe and Fittings may be installed without protection (exposed) as a vertical riser when subject to the following additional limitations:

- An automatic sprinkler (of the same type as in the area being protected) shall be located adjacent to and no further than 1 ft (0,3 m) from the riser.

- The automatic sprinkler protecting the riser shall not be considered when determining protection criteria for the floor area. The design flow for the sprinkler protecting the riser must be the same as for the other sprinklers, and must be added to the hydraulic calculation.
- Solvent cement joints shall be made with TFP-600 or BM-5 One Step Solvent Cement.

The Loss Prevention Council (LPCB)

Use of IPEX CPVC Fire Sprinkler Systems in Accordance with The Loss Prevention Council (LPCB) "List of Approved Products and Services", Part 5, "Automatic Sprinkler, Water Spray, and Deluge Systems" Section 21.1 "Plastic Pipes and Fittings" and Section 5 of BS 5306: Part 2.

The Loss Prevention Certification Board Listing is as follows:

1. The 'scope of use' of plastic pipe should be agreed upon between the purchaser, authority having jurisdiction, and/or insurer.
2. Use of plastic pipe and fittings is subject to water authority agreement for the territory concerned.
3. LPCB Approved quick response sprinklers shall be used with exposed (e.g., fire exposure) plastic pipe and fittings.
4. Plastic pipe and fittings are suitable for use only with wet pipe systems.
5. Care should be exercised to ensure that joints are adequately cured, in accordance with the manufacturer's installation instruction, prior to pressurization.
6. Plastic pipe and fittings shall not be installed outdoors.
7. Where plastic pipe and fittings are exposed (for example, fire exposure), the system shall be installed close to a flat ceiling construction.
8. Sprinkler systems that employ plastic pipe and fittings shall be designed where possible to ensure no "no flow" sections of pipe work in the event of sprinkler operation.
9. LPCB maximum ambient temperature of 50°C.

The Loss Prevention Certification Board listing applies to Light Hazard Classifications BS 5306: Part 2, Section 5.2 fall within the scope of NFPA 13, 13R and 13D.

In addition, IPEX fire sprinkler systems can be installed in certain ordinary classification (BS 5306: Part 2, Section 5.3) such as offices, retail shops and department stores when installed in accordance with Section 22 of LPCB "List of Approved Products and Services".

IPEX CPVC Pipe and Fittings should not be used in high hazard applications (BS 5306: Part 2, Section 5.4) and ordinary hazard applications where the fuel load or rate of heat release is high, such as boiler rooms, kitchens, manufacturing areas, and certain warehouse applications.

Solvent cement joints shall be made with TFP-600 or BM-5 One Step Solvent Cement.

Fittings

IPEX CPVC sprinkler fittings conform to the requirements of ASTM F438 (Schedule 40 dimensions from 3/4 in. to 1 1/2 in. (DN20 to DN32), ASTM F439 (Schedule 80 dimensions for 1 1/2 in. to 3 in. (DN40 to DN80) and ASTM F1970 (Transition Fittings). Rapid Seal Adapter (RSA) threaded sprinkler connection fittings and slip style fittings carry the NSF International (NSF-pw) mark for use in potable water systems. All other threaded sprinkler adapter fittings feature brass inserts and are not NSF-pw rated. See Appendix A for sprinkler fittings types, sizes, socket and take-out dimensions.

Solvent Cement

IPEX CPVC socket connections shall be joined using TFP-600 or BM-5 One Step Solvent Cement as indicated in the "Listing and Approvals" section. TFP-600 or BM-5 One Step Solvent Cement meets ASTM F493, NSF, FM, UL and LPCB requirements. Review solvent cementing instructions within this handbook prior to installation.

PRODUCT RATINGS AND CAPABILITIES

Ambient Temperature and Heat Sources

IPEX CPVC Pipe and Fittings shall be installed in areas where the ambient temperature does not exceed 150°F (65°C). (LPCB maximum ambient temperature of 50°C)

Before penetrating fire rated walls and partitions, consult building codes and authorities having jurisdiction in your area. IPEX CPVC systems should be designed and installed so that the piping is not closely exposed to high heat producing sources, such as incandescent light, ballasts, and steam lines.

Pressure Rating

IPEX CPVC Pipe and Fittings are Listed/Approved for a rated pressure of 175 psi (12,1 bar) and a maximum ambient temperature of 150°F (65°C). (LPCB maximum ambient temperature of 50°C)

Friction Loss

IPEX CPVC Pipe has a Hazen-Williams C-Value of 150. Pipe friction loss calculations shall be made according to NFPA Standards. Tables F1 and F2 show the allowance of friction loss for fittings, expressed in equivalent feet of pipe.

Table F1
Allowance for Friction Loss in Fittings³

Fitting Size ANSI Inches	3/4	1	1 1/4	1 1/2	2	2 1/2	3
Tee Branch- ft	3	5	6	8	10	12	15
Elbow 90° ¹ - ft	4	5	6	7	9	12	13
Elbow 45°- ft	1	1	2	2	2	3	4
Coupling- ft	1	1	1	1	1	2	2
Tee Run ² - ft	1	1	1	1	1	2	2

Table F2
Allowance for Friction Loss in Fittings³

Fitting Size DN	DN20	DN25	DN32	DN40	DN50	DN65	DN80
Tee Branch- m	0,9	1,5	1,8	2,4	3,1	3,7	4,6
Elbow 90° ¹ - m	1,2	1,5	1,8	2,1	2,7	3,7	4,0
Elbow 45°- m	0,3	0,3	0,6	0,6	0,6	0,9	1,2
Coupling- m	0,3	0,3	0,3	0,3	0,3	0,6	0,6
Tee Run ² - m	0,3	0,3	0,3	0,3	0,3	0,6	0,6

1. The above stated friction loss values are for IPEX fittings only. When using other Listed IPEX CPVC 90° elbows with BLAZEMASTER products, consult the fitting manufacturer's installation and design manuals.

2. Per manufacturer's test.

Thermal Expansion – U.S. Units

IPEX CPVC Pipe, like all piping materials, expands and contracts with changes in temperature. The coefficient of linear expansion for IPEX CPVC Pipe is: 0.000034 in/in/°F. The coefficient of linear expansion IPEX CPVC Pipe is the same for all pipe sizes.

To determine the linear expansion of the pipe due to thermal changes use the following formula:

$$\Delta L = 12eL (\Delta T)$$

Where:

e = 0.000034 in/in/°F (coefficient of linear expansion)

L = Length of run in feet

ΔT = Temperature change in °F

ΔL = Inches

Example: How much will a 40 foot run of 3/4 inch IPEX CPVC Pipe increase in length (or expand) if the expected ambient temperature ranges from 35°F to 85°F? Changes in length due to fittings are insignificant relative to the pipe.

$$\Delta L = 12eL (\Delta T)$$

$$\Delta L = 12 (0.000034) \times 40 \times 50$$

$$\Delta L = 0.82 \text{ inch or approximately } 13/16 \text{ inch}$$

IPEX CPVC exhibits a relatively high coefficient of thermal expansion. When designing CPVC fire sprinkler systems, expansion of long runs must be considered if temperature variations will be encountered (i.e., summer to winter extremes). Methods of compensating for thermal expansion are expansion loops, offsets and change of direction of the pipe run shown in Figure 7.

Loop Lengths "L" for use in Figure 7 are shown in Tables H1, J1, and K1. If the change in temperature and the maximum working temperature are lower than those used to derive the tables, the numbers will be conservative in nature. For example, for a temperature change from 60°F to 125°F use Table J1 because the maximum temperature is greater than those shown in Tables G1 and H1.

For conditions that are not covered in the Loop Length Tables, use the following formula:

$$L = \sqrt{\frac{3ED(\Delta L)}{2S}}$$

Where:

L = Length of loop, offset, or change of direction in inches

E = Modulus of elasticity at the maximum temperature (Table L1) in psi

D = Nominal outside diameter of pipe (Table D1) in inches

ΔL = Change in length of pipe due to change in temperature in inches

S = Working stress at the maximum temperature (Table L1) in psi

Example: How much expansion can be expected in a 240 foot run of 2 inch IPEX CPVC Pipe installed in 40°F given a maximum temperature change to 100°F? Additionally, how long should the expansion loop be to compensate for this expansion?

Step 1. Find the temperature change expressed as ΔT.

$$\Delta T = 100^\circ\text{F} - 40^\circ\text{F}$$

$$\Delta T = 60^\circ\text{F}$$

Step 2. Calculate the change in length expressed as ΔL.

$$\Delta L = 12 e L (\Delta T)$$

$$\Delta L = 12 (0.000034) \times 240 \times 60$$

$$\Delta L = 5.88 \text{ inches}$$

Step 3. Find the length of the expansion loop or offset in inches

$$L = \sqrt{\frac{3ED(\Delta L)}{2S}}$$

L = Length of loop, offset, or change of direction in inches

E = Modulus of elasticity at maximum temperature (Table L1)

in psi

D = Nominal outside diameter of pipe (Table D1) in inches

S = Working stress at maximum temperature (Table L1) psi

ΔL = Change in length of pipe due to a change in temperature from Step 2 in inches

$$L = \sqrt{\frac{3 \times (3.85 \times 10^5) (2.375) (5.88)}{2 \times 1560}}$$

$$L = 71.90 \text{ inches}$$

Step 4. Refer to Figure 7.

a- For loop length: $1/5 L = 1/5 \times 71.90 = 14.38 \text{ inches}$

$2/5 L = 2/5 \times 71.90 = 28.76 \text{ inches}$

b- For offset length: $1/4 L = 1/4 \times 71.90 = 17.98 \text{ inches}$

$1/2 L = 1/2 \times 71.90 = 35.95 \text{ inches}$

c- For change of direction length: $L = 71.90 \text{ inches}$

Thermal Expansion – Metric Units

IPEX CPVC Pipe, like all piping materials, expands and contracts with changes in temperature. The coefficient of linear expansions IPEX CPVC Pipe is: 0,062 mm/m/°C. The coefficient of linear expansion IPEX CPVC Pipe is the same for all pipe sizes.

To determine the linear expansion of the pipe due to thermal changes use the following formula:

$$\Delta L = eL (\Delta T)$$

Where:

e = 0,061 mm/m °C (coefficient of linear expansion)

L = Length of run in meters

ΔT = Temperature change in °C

Example: How much will a 12 m run of DN20 IPEX CPVC Pipe increase in length (or expand) if the expected ambient temperature ranges from 2°C to 32°C? Changes in length due to fittings are insignificant relative to the pipe.

$$\Delta L = eL (\Delta T)$$

$$\Delta L = (0,061) \times 12 \times 30$$

$$\Delta L = 22,0 \text{ mm}$$

IPEX CPVC exhibits a relatively high coefficient of thermal expansion (see Table H2). When designing IPEX sprinkler systems, expansion of long runs must be considered if temperature variations will be encountered (i.e., summer to winter extremes). Methods of compensating for thermal expansion are expansion loops, offsets and change of direction of the pipe run shown in Figure 7.

Loop Lengths "L" for use in Figure 7 are shown in Tables H2, J2, and K2. If the change in temperature and the maximum working temperature are lower than those used to derive the tables, the numbers will be conservative in nature. For example, for a temperature change from 16°C to 52°C use Table J2 because the maximum temperature is greater than those shown in Tables G2 and H2.

For conditions that are not covered in the Loop Length Tables, use the following formula:

$$L = \sqrt{\frac{3ED(\Delta L)}{2S}}$$

Where:

L = Length of loop, offset, or change of direction in millimeters

E = Modulus of elasticity at the maximum temperature (Table L2) in bar

D = Nominal outside diameter of pipe (Table D2) in millimeters

ΔL = Change in length of pipe due to change in temperature in millimeters

S = Working stress at the maximum temperature (Table L2) in bar

Example: How much expansion can be expected in a 73 m run of DN50 IPEX CPVC Pipe installed in 4°C given a maximum temperature change to 38°C? Additionally, how long should the expansion loop be to compensate for this expansion?

Step 1. Find the temperature change expressed as ΔT.

$$\Delta T = 38^{\circ}\text{C} - 4^{\circ}\text{C}$$

$$\Delta T = 34^{\circ}\text{C}$$

Step 2. Calculate the change in length expressed as ΔL.

$$\Delta L = e L (\Delta T)$$

$$\Delta L = 0,061 \times 73 \times 34$$

$$\Delta L = 151,4 \text{ mm}$$

Step 3. Find the length of the expansion loop or offset in millimeters

$$L = \sqrt{\frac{3ED(\Delta L)}{2S}}$$

L = Length of loop, offset, or change of direction in millimeters

E = Modulus of elasticity at the maximum temperature (Table L2) in bar

D = Average outside diameter of pipe (Table D2) in millimeters

S = Working stress at the maximum temperature (Table L2) in bar

ΔL = Change in length of pipe due to a change in temperature from Step 2 in millimeters

$$L = \sqrt{\frac{3 \times 26546 \times 60,3 \times 151,4}{2 \times 107,6}}$$

$$L = 1838 \text{ mm}$$

Step 4. Refer to Figure 7.

a- For loop length: $1/5 L = 1/5 \times 1838 \text{ mm} = 368 \text{ mm}$
 $2/5 L = 2/5 \times 1838 \text{ mm} = 735 \text{ mm}$

b- For offset length: $1/4 L = 1/4 \times 1838 \text{ mm} = 460 \text{ mm}$
 $1/2 L = 1/2 \times 1838 \text{ mm} = 919 \text{ mm}$

c- For change of direction length: $L = 1838 \text{ mm}$

Table G1 - Thermal Expansion U.S. Units

Length of Run Feet	Temperature Change ΔT °F								
	20	30	40	50	60	70	80	90	100
	Thermal Expansion, ΔL Inches								
5	0.04	0.06	0.08	0.10	0.12	0.14	0.16	0.18	0.20
10	0.08	0.12	0.16	0.20	0.24	0.29	0.33	0.37	0.41
15	0.12	0.18	0.24	0.31	0.37	0.43	0.49	0.55	0.61
20	0.16	0.24	0.33	0.41	0.49	0.57	0.65	0.73	0.82
25	0.20	0.31	0.41	0.51	0.61	0.71	0.82	0.92	1.02
30	0.24	0.37	0.49	0.61	0.73	0.86	0.98	1.10	1.22
35	0.29	0.43	0.57	0.71	0.86	1.00	1.14	1.29	1.43
40	0.33	0.49	0.65	0.82	0.98	1.14	1.31	1.47	1.63
45	0.37	0.55	0.73	0.92	1.10	1.29	1.47	1.65	1.84
50	0.41	0.61	0.82	1.02	1.22	1.43	1.63	1.84	2.04
70	0.57	0.86	1.14	1.43	1.71	2.00	2.28	2.57	2.86
90	0.73	1.10	1.47	1.84	2.20	2.57	2.94	3.30	3.67
120	0.98	1.47	1.96	2.45	2.94	3.43	3.92	4.41	4.90
160	1.31	1.96	2.61	3.26	3.92	4.57	5.22	5.88	6.53

Table G2 - Thermal Expansion Metric Units

Length of Run Meters	Temperature Change ΔT °C								
	10	15	20	25	30	35	40	50	55
	Thermal Expansion, ΔL Millimeters								
1	0,6	0,9	1,2	1,5	1,8	2,1	2,4	3,1	3,4
2	1,2	1,8	2,4	3,1	3,7	4,3	4,9	6,1	6,7
3	1,8	2,7	3,7	4,6	5,5	6,4	7,3	9,2	10,1
4	2,4	3,7	4,9	6,1	7,3	8,5	9,8	12,2	13,4
5	3,1	4,6	6,1	7,6	9,2	10,7	12,2	15,3	16,8
7	4,3	6,4	8,5	10,7	12,8	14,9	17,1	21,4	23,5
9	5,5	8,2	11,0	13,7	16,5	19,2	22,0	27,5	30,2
12	7,3	11,0	14,6	18,3	22,0	25,6	29,3	36,6	40,3
15	9,2	13,7	18,3	22,9	27,5	32,0	36,6	45,8	50,3
20	12,2	18,3	24,4	30,5	36,6	42,7	48,8	61,0	67,1
25	15,3	22,9	30,5	38,1	45,8	53,4	61,0	76,3	83,9
30	18,3	27,5	36,6	45,8	54,9	64,1	73,2	91,5	100,7
40	24,4	36,6	48,8	61,0	73,2	85,4	97,6	122,0	134,2
50	30,5	45,8	61,0	76,3	91,5	106,8	122,0	152,5	167,8

Table H1 - U.S. Units
Loop Length (30°F to 100°F) $\Delta T = 70^\circ F$

Length of Run Feet	Nominal Pipe Size – O.D. & ANSI Inches						
	3/4 1.050	1 1.315	1 1/4 1.660	1 1/2 1.900	2 2.375	2 1/2 2.875	3 3.500
	Length of Loop – Inches						
10	11	12	13	14	16	18	19
20	15	17	19	20	22	25	27
30	18	20	23	25	27	30	33
40	21	24	26	28	32	35	38
50	24	26	30	32	35	39	43
60	26	29	32	35	39	43	47
70	28	31	35	38	42	46	51
80	30	33	37	40	45	49	54
90	32	35	40	43	48	52	58
100	33	37	42	45	50	55	61
120	37	41	46	49	55	60	67
140	39	44	50	53	59	65	72
160	42	47	53	57	63	70	77

Note: Table based on Stress and Modulus of Elasticity at 100°F.
Refer to Table K1.
 $\Delta T = 70^\circ F$, $S = 1560$ psi, $E = 3.85 \times 10^5$ psi

Table H2 – Metric Units
Loop Length (0°C to 40°C) $\Delta T = 40^\circ C$

Length of Run Meters	Nominal Pipe Size – O.D. & DN, mm						
	DN20 26,7	DN25 33,4	DN32 42,2	DN40 48,3	DN50 60,3	DN65 73,0	DN80 88,9
	Length of Loop – Meters						
3	0,3	0,3	0,3	0,4	0,4	0,4	0,5
5	0,3	0,4	0,4	0,5	0,5	0,6	0,6
10	0,5	0,5	0,6	0,7	0,7	0,8	0,9
15	0,6	0,7	0,8	0,8	0,9	1,0	1,1
20	0,7	0,8	0,9	0,9	1,0	1,1	1,3
25	0,8	0,9	1,0	1,0	1,2	1,3	1,4
30	0,9	1,0	1,1	1,1	1,3	1,4	1,6
35	0,9	1,0	1,2	1,2	1,4	1,5	1,7
40	1,0	1,1	1,2	1,3	1,5	1,6	1,8
45	1,0	1,2	1,3	1,4	1,6	1,7	1,9
50	1,1	1,2	1,4	1,5	1,6	1,8	2,0
55	1,2	1,3	1,5	1,5	1,7	1,9	2,1
60	1,2	1,3	1,5	1,6	1,8	2,0	2,2

Note: Table based on Stress and Modulus of Elasticity at 40°C.
Refer to Table K2.
 $\Delta T = 38,9^\circ C$, $S = 107,6$ bar, $E = 26546$ bar

Table J1 - U.S. Units
Loop Length (60°F to 120°F) $\Delta T = 60^\circ F$

Length of Run Feet	Nominal Pipe Size – O.D. & ANSI Inches						
	3/4 1.050	1 1.315	1 1/4 1.660	1 1/2 1.900	2 2.375	2 1/2 2.875	3 3.500
	Length of Loop – Inches						
10	10	12	13	14	16	17	19
20	15	16	18	20	22	24	27
30	18	20	22	25	27	30	33
40	21	23	26	28	31	34	38
50	23	26	29	31	35	38	42
60	25	28	32	34	38	42	46
70	27	31	34	37	41	45	50
80	29	33	37	39	44	48	54
90	31	35	39	42	47	51	57
100	33	37	41	44	49	54	60
120	36	40	45	48	54	59	66
140	39	43	49	52	58	64	71
160	41	46	52	56	62	69	76

Note: Table based on Stress and Modulus of Elasticity at 120°F.
Refer to Table K1.
 $\Delta T = 60^\circ F$, $S = 1275$ psi, $E = 3.55 \times 10^5$ psi

Table J2 - Metric Units
Loop Length (15°C to 50°C) $\Delta T = 35^\circ C$

Length of Run Meters	Nominal Pipe Size – O.D. & DN, mm						
	DN20 26,7	DN25 33,4	DN32 42,2	DN40 48,3	DN50 60,3	DN65 73,0	DN80 88,9
	Length of Loop – Meters						
3	0,3	0,3	0,3	0,4	0,4	0,4	0,5
5	0,3	0,4	0,4	0,5	0,5	0,6	0,6
10	0,5	0,5	0,6	0,7	0,7	0,8	0,9
15	0,6	0,7	0,8	0,8	0,9	1,0	1,1
20	0,7	0,8	0,9	0,9	1,0	1,1	1,3
25	0,8	0,9	1,0	1,0	1,2	1,3	1,4
30	0,8	0,9	1,1	1,1	1,3	1,4	1,5
35	0,9	1,0	1,2	1,2	1,4	1,5	1,7
40	1,0	1,1	1,2	1,3	1,5	1,6	1,8
45	1,0	1,2	1,3	1,4	1,6	1,7	1,9
50	1,1	1,2	1,4	1,5	1,6	1,8	2,0
55	1,1	1,3	1,4	1,5	1,7	1,9	2,1
60	1,2	1,3	1,5	1,6	1,8	2,0	2,2

Note: Table based on Stress and Modulus of Elasticity at 50°C.
Refer to Table K2.
 $\Delta T = 33,4^\circ C$, $S = 87,9$ bar, $E = 24477$ bar

Table K1 - U.S. Units
Loop Length (70°F to 150°F) $\Delta T = 80^\circ F$

Length of Run Feet	Nominal Pipe Size – O.D. & ANSI Inches						
	3/4 1.050	1 1.315	1 1/4 1.660	1 1/2 1.900	2 2.375	2 1/2 2.875	3 3.500
	Length of Loop – Inches						
10	14	15	17	18	20	22	25
20	19	21	24	26	29	31	35
30	23	26	29	31	35	39	43
40	27	30	34	36	41	45	49
50	30	34	38	40	45	50	55
60	33	37	41	44	50	55	60
70	36	40	45	48	53	59	65
80	38	43	48	51	57	63	69
90	40	45	51	54	61	67	74
100	43	48	53	57	64	70	78
120	47	52	59	63	70	77	85
140	50	56	63	68	76	83	92
160	54	60	68	72	81	89	98

Note: Table based on Stress and Modulus of Elasticity at 150°F.
Refer to Table K1.

$$\Delta T = 80^\circ F, S = 875 \text{ psi}, E = 3.08 \times 10^5 \text{ psi}$$

Table K2 - Metric Units
Loop Length (20°C to 65°C) $\Delta T = 45^\circ C$

Length of Run Meters	Nominal Pipe Size – O.D. & DN, mm						
	DN20 26,7	DN25 33,4	DN32 42,2	DN40 48,3	DN50 60,3	DN65 73,0	DN80 88,9
	Length of Loop – Meters						
3	0,3	0,4	0,4	0,5	0,5	0,6	0,6
5	0,4	0,5	0,6	0,6	0,7	0,7	0,8
10	0,6	0,7	0,8	0,8	0,9	1,0	1,1
15	0,8	0,9	1,0	1,0	1,1	1,3	1,4
20	0,9	1,0	1,1	1,2	1,3	1,5	1,6
25	1,0	1,1	1,2	1,3	1,5	1,6	1,8
30	1,1	1,2	1,4	1,4	1,6	1,8	2,0
35	1,2	1,3	1,5	1,6	1,7	1,9	2,1
40	1,2	1,4	1,6	1,7	1,9	2,1	2,3
45	1,3	1,5	1,7	1,8	2,0	2,2	2,4
50	1,4	1,6	1,8	1,9	2,1	2,3	2,5
55	1,5	1,6	1,8	2,0	2,2	2,4	2,7
60	1,5	1,7	1,9	2,1	2,3	2,5	2,8

Note: Table based on Stress and Modulus of Elasticity at 65°C.
Refer to Table K2.

$$\Delta T = 44,5^\circ C, S = 60,3 \text{ bar}, E = 21237 \text{ bar}$$

Table L1

Modulus of Elasticity & Stress vs Temperature – U.S. Units

Temperature °F	73°	80°	90°	100°	110°	120°	140°	150°
Modulus of Elasticity "E" x 10 ⁵ (psi)	4.23	4.14	3.99	3.85	3.70	3.55	3.23	3.08
Working Stress "S" (psi)	2,000	1,875	1,715	1,560	1,415	1,275	1,000	875

Table L2

Modulus of Elasticity & Stress vs Temperature – Metric Units

Temperature °C	25°	30°	35°	40°	45°	50°	60°	65°
Modulus of Elasticity (bar)	29166	28545	27511	26546	25512	24477	22271	21237
Working Stress "S" (bar)	137,9	129,3	118,2	107,6	97,6	87,9	69,0	60,3

Figure 7

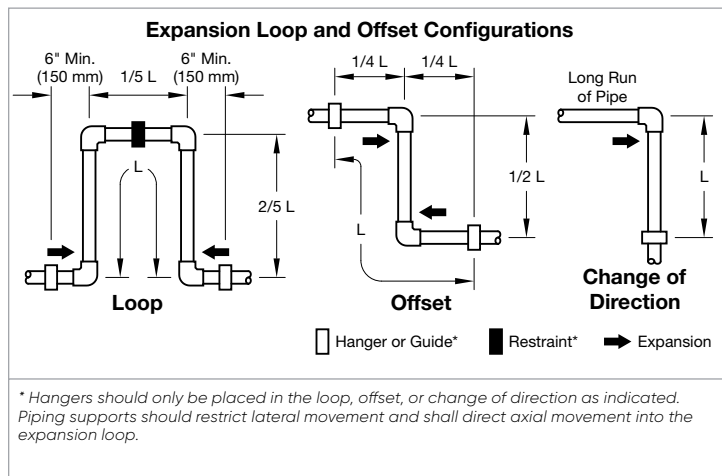

PHYSICAL AND THERMAL PROPERTIES

Table M – Physical and Thermal Properties

Property		CPVC	ASTM
Specific Gravity	"Sp.Gr."	1.53	D792
IZOD Impact Strength (ft-lbs/in., notched)		3.0	D256A
Modulus of Elasticity, @73°F, psi		"E"	4.23 x 10 ⁵
Ultimate Tensile Strength, psi		8,000	D638
Compressive Strength, psi		"o"	9,600
Poisson's Ratio		"n"	.35 - .38
Working Stress @ 73°F, psi		"S"	2,000
Hazen Williams "C" Factor		"C"	150
Coefficient of Linear Expansion in/(in °F)		"e"	3.4 x 10 ⁻⁵
Thermal Conductivity BTU/hr/ft ² /°F/in		"k"	0.95
Flash Ignition Temperature		°F	900
Limiting Oxygen Index		"LOI"	60%
Electrical Conductivity		Non Conductor	

Permissible Bending Deflections

IPEX CPVC fire sprinkler piping while classified as a rigid piping material is inherently flexible. This flexibility allows piping to be deflected within permissible limits around or away from objects during installation.

The maximum allowable deflections for IPEX CPVC piping can be found in Tables N1 and N2 and Table P1 and P2.

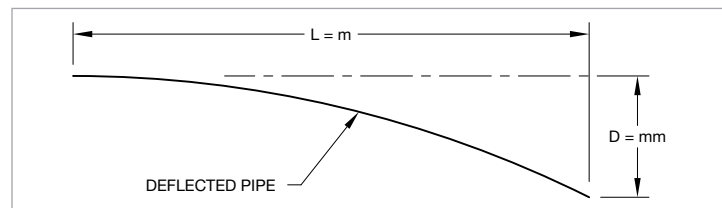
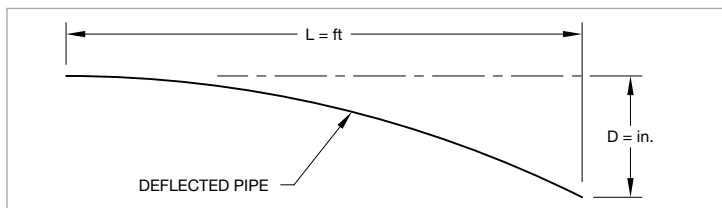

Table N1 - U.S. Units (1 of 2)
Permissible Bending Deflections SDR 13.5 at 73°F
"Bending" (One End Restrained)

(L) Length of Run Feet	Nominal Pipe Size – ANSI Inches						
	3/4	1	1 1/4	1 1/2	2	2 1/2	3
	(D) Deflection - Inches						
2	1.3	1.0	0.8	0.7	0.6	0.5	0.4
5	7.8	6.3	5.0	4.3	3.5	2.9	2.4
7	15.4	12.3	9.7	8.5	6.8	5.6	4.6
10	31.3	25.0	19.8	17.3	13.9	11.4	9.4
12	45.1	36.0	28.5	24.9	20.0	16.5	13.5
15	70.5	56.3	44.6	39.0	31.2	25.8	21.2
17	90.6	72.3	57.3	50.1	40.0	33.1	27.2
20	125.4	100.1	79.3	69.3	55.4	45.8	37.6
25	195.9	156.4	123.9	108.2	86.6	71.5	58.8
30	282.1	225.2	178.4	155.9	124.7	103.0	84.6
35	383.9	306.6	242.8	212.2	169.7	140.2	115.2
40	–	400.4	317.2	277.1	221.7	183.1	150.4
45	–	–	401.4	350.7	280.6	231.8	190.4
50	–	–	–	433.0	346.4	286.2	235.1

Table N2 – Metric Units
Permissible Bending Deflections SDR 13.5 at 23°C
"Bending" (One End Restrained)

(L) Length of Run Meters	Nominal Pipe Size – DN						
	DN20	DN25	DN32	DN40	DN50	DN65	DN80
	(D) Deflection - Meters						
0.5	0,02	0,02	0,01	0,01	0,01	0,01	0,01
1	0,09	0,07	0,05	0,05	0,04	0,03	0,03
2	0,34	0,27	0,22	0,19	0,15	0,13	0,10
3	0,77	0,62	0,49	0,43	0,34	0,28	0,23
4	1,37	1,10	0,87	0,76	0,61	0,50	0,41
5	2,15	1,71	1,36	1,19	0,95	0,78	0,64
6	3,09	2,47	1,96	1,71	1,37	1,13	0,93
7	4,21	3,36	2,66	2,33	1,86	1,54	1,26
8	5,50	4,39	3,48	3,04	2,43	2,01	1,65
9	6,96	5,55	4,40	3,84	3,08	2,54	2,09
10	8,59	6,86	5,43	4,75	3,80	3,14	2,58
11	–	8,30	6,57	5,74	4,59	3,80	3,12
13	–	–	9,18	8,02	6,42	5,30	4,35
15	–	–	–	10,68	8,54	7,06	5,80

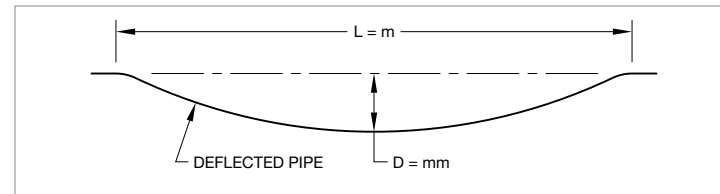
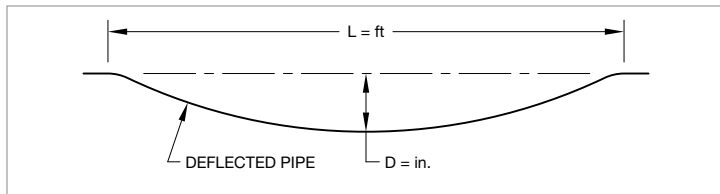

Table P1 - U.S. Units (1 of 2)
Permissible Bending Deflections SDR 13.5 at 73°F
"Snaking" (Both Ends Restrained)

(L) Length of Run Feet	Nominal Pipe Size - ANSI Inches						
	3/4	1	1 1/4	1 1/2	2	2 1/2	3
	(D) Deflection - Inches						
2	0.3	0.3	0.2	0.2	0.1	0.1	0.1
5	2.0	1.6	1.2	1.1	0.9	0.7	0.6
7	3.8	3.1	2.4	2.1	1.7	1.4	1.2
10	7.8	6.3	5.0	4.3	3.5	2.9	2.4
12	11.3	9.0	7.1	6.2	5.0	4.1	3.4
15	17.6	14.1	11.2	9.7	7.8	6.4	5.3
17	22.6	18.1	14.3	12.5	10.0	8.3	6.8
20	31.3	25.0	19.8	17.3	13.9	11.4	9.4
25	49.0	39.1	31.0	27.1	21.6	17.9	14.7
30	70.5	56.3	44.6	39.0	31.2	25.8	21.2
35	96.0	76.6	60.7	53.0	42.4	35.1	28.2
40	125.4	100.1	79.3	69.3	55.4	45.8	37.6
45	158.7	126.7	100.4	87.7	70.1	57.9	47.6
50	195.9	156.4	123.9	108.2	86.6	71.5	58.8

Table P2 - Metric Units
Permissible Bending Deflections SDR 13.5 at 23°C
"Snaking" (Both Ends Restrained)

(L) Length of Run Meters	Nominal Pipe Size - DN						
	DN20	DN25	DN32	DN40	DN50	DN65	DN80
	(D) Deflection - Meters						
0.61	0,008	0,006	0,005	0,004	0,004	0,003	0,002
1	0,022	0,017	0,014	0,012	0,010	0,008	0,006
2	0,086	0,069	0,054	0,048	0,038	0,031	0,026
3	0,194	0,155	0,122	0,107	0,086	0,071	0,058
4	0,344	0,275	0,218	0,190	0,152	0,126	0,103
5	0,538	0,429	0,340	0,297	0,238	0,196	0,161
6	0,774	0,618	0,490	0,428	0,342	0,283	0,232
7	1,054	0,842	0,667	0,582	0,466	0,385	0,316
8	1,377	1,099	0,871	0,761	0,609	0,503	0,413
9	1,742	1,391	1,102	0,963	0,770	0,636	0,523
10	2,151	1,718	1,361	1,189	0,951	0,786	0,645
11	—	2,078	1,646	1,438	1,151	0,951	0,781
13	—	—	2,299	2,009	1,607	1,328	1,091
15	—	—	—	2,675	2,140	1,768	1,452

SUPPORT AND HANGER REQUIREMENTS

Special care must be exercised when selecting the appropriate hanger or support method for IPEX CPVC Fire Sprinkler Systems.

IPEX CPVC Fire Sprinkler Systems may be supported as follows:

- Using the same hangers as metal piping systems that meet the requirements of this section
- Using hangers specifically listed for thermoplastic sprinkler piping
- Using any other support method acceptable to the local authority having jurisdiction

When using hangers/restraining devices, ensure that the hangers are clean, free of burrs, and free of all surface oils. Any foreign substance must be removed from the hanger.

When plumbers tape or J hooks are permitted by the authority having jurisdiction, for example NFPA 13D applications, rough edges are to be shielded.

Avoid using hangers of the incorrect size for the pipe being fastened/hung as the hanger can pinch, crush, and damage the piping system causing it to leak or crack under pressure. Leaks may not appear until after the pipe is in service.

The pipe size of the hanger shall be the same size as the supported pipe, and the hanger shall be applied to the pipe (i.e., not the fittings). Horizontal runs of piping must be braced so that stress loads (caused by bending or snaking the pipe) will not be placed on a fitting or joint. In jurisdictions that do not allow plastic to metal contact, rigid plastic sleeves should be used to isolate the materials. Strapping pipe overly tight to a structural member may cause damage to the pipe when pressurized. The pipe should be held snugly by the hanger, but cannot be pinched or crushed in any way. Pipe hangers must comply NFPA 13, NFPA 13D, NFPA 13R, or the standard recognized by the applicable Approval Agency, as appropriate.

Exception: In installations where IPEX CPVC Pipe is attached tight to a continuous ceiling with a "strap" style hanger, undue stress may be placed on the pipe. The outside dimension of the fitting is greater than that of the pipe and this size difference can create an unacceptable deflection of the pipe when the strap is located directly adjacent to the fitting. In this case only, and when the fitting is tight to the ceiling, it would be acceptable to use a hanger that is one size larger than the pipe. The use of such an oversized hanger would avoid the stress on the pipe.

Some hangers designed for metal pipe are suitable for use with IPEX CPVC Fire Sprinklers Systems. Hangers must not have rough or sharp edges that can come in contact with the pipe. Pipe hangers must have a load bearing surface at least 1/2 in. (12,7 mm) wide.



SHB1 Head Set

There are several types of hangers, that have been specifically listed as "Support Devices For Thermoplastic Piping," such as Tolco (Model 22, 23, 24), Afcon (# 510, 511, 512) and Erico (No. 107, 108, 109). Consult the specific manufacturer for information on the

appropriateness of these devices as hangers and/or vertical restraining devices for use with IPEX CPVC Pipe and Fittings.

Pipe Bracing with Standard Band Hanger

A One Hole Strap, shown below, can function as a hanger and as a restraining device. As a restraining device, invert the hanger so that the fastener is downward. Installation in this manner will prevent upward movement of the sprinkler during activation.

A Two Hole Strap, shown below, can function as a hanger and as a restraining strap. UL Listed CPVC hangers incorporate features that protect the pipe from sharp edges and ease installation. The hex head self-threading screw (furnished with most UL Listed CPVC hangers) is easily installed using a rechargeable electric drill and a 5/16 in. (8,0 mm) socket attachment. No pre-drilling of a pilot hole is required.

Local codes have final authority on which types of hangers may be used.

Hanger/Support Spacing



One Hole Strap



Two Hole Strap

Because IPEX pipe is more rigid than other types of plastic pipe systems, the support spacing shown in Table R shall be adhered to when installing the system. For exposed installations, Listed support devices shall be used that mount piping directly to the ceiling or side wall, except when using upright sprinklers per the installation information in the Listings & Approvals Section of this handbook.

When the piping is supported by wood joists or trusses by laying the pipe directly on top of the structural members, the structure provides the support, assuming that the center spacing of the structural member does not exceed the requirements of Table Q.

Table Q
Maximum Support Spacing "L" (Feet) CPVC SDR 13.5

Nominal Pipe Size ANSI Inches (DN)	3/4 DN20	1 DN25	1 1/4 DN32	1 1/2 DN40	2 DN50	2 1/2 DN65	3 DN80
Support Spacing in Feet (m)	5-1/2 (1,7)	6 (1,8)	6-1/2 (2,0)	7 (2,1)	8 (2,4)	9 (2,7)	10 (3,0)

Vertical Restraint

When a sprinkler activates, a significant reactive force is exerted on the pipe, especially at system static pressures greater than 100 psi (6,9 bar). The reactive force will cause the pipe to lift vertically if it is not properly secured, especially if the sprinkler drop is from a small diameter pipe.

When a sprinkler drop is 3/4 in. (DN19) to 1 1/4 in. (DN32) pipe, the closest hanger should brace the pipe against vertical lift. A number of techniques can be used to brace the pipe such as a standard band hanger positioning the threaded support rod to 1/16 in. (1,6 mm) above the pipe or using a split ring or a wrap-around hanger for restraint.

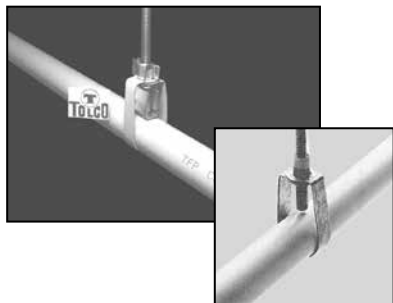

Note: Threaded rod shall not come in contact with CPVC when installed. It is advisable to use lift restraint devices such as those produced by Tolco and Afcon that prevent the threaded rod from coming in contact with the CPVC pipe (as shown above).

Branch lines shall be braced at a distance from a tee or elbow to prevent lift of sprinklers as shown in Tables R or S.

The hangers used for vertical restraint can also serve as the hangers for "Hanger/Support Spacing."

Table R - One Point of Restraint

Nominal Pipe Size ANSI Inches DN	"N" Less than 100 psi (6,9 bar)	"N" Greater than 100 psi (6,9 bar)
3/4 DN20	0'-9" (0,23 m)	0'-6" (0,15 m)
1 DN25	1'-0" (0,30 m)	0'-9" (0,23 m)
1 1/4 DN32	1'-4" (0,41 m)	1'-0" (0,30 m)
1 1/2 - 3 DN40 - DN80	2'-0" (0,61 m)	1'-0" (0,30 m)

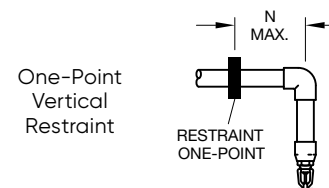
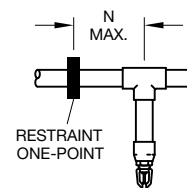

One-Point
Vertical
Restraint

Table S - Two Points of Restraint

Nominal Pipe Size ANSI Inches DN	"M" Less than 100 psi (6,9 bar)	"M" Greater than 100 psi (6,9 bar)
3/4 DN20	4'-0" (1,22 m)	3'-0" (0,91 m)
1 DN25	5'-0" (1,52 m)	4'-0" (1,22 m)
1 1/4 DN32	6'-0" (1,83 m)	5'-0" (1,52 m)
1 1/2 - 3 DN40 - DN80	7'-0" (2,13 m)	7'-0" (2,13 m)

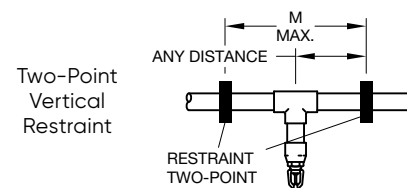

Two-Point
Vertical
Restraint

Sway Bracing Guidance for CPVC

Sway bracing for BLAZEMASTER shall be designed and installed per NFPA 13. Compressive load shall not be placed on CPVC pipe. Many common longitudinal sway braces exert compressive load on the pipe through a clamp and shall not be used with CPVC products. In order to avoid this, the installer should use lateral sway braces designed for use with CPVC pipe in one of the following manners. In accordance with NFPA 13, a lateral sway brace may be used as a longitudinal brace if they are within 24 in. of the centerline of the piping to be braced longitudinally and the lateral brace is on a pipe of equal or greater size than the pipe being braced longitudinally. If a line of equal or greater size is not available in the location of longitudinal bracing, a dead leg may be installed. This dead leg may be used to longitudinally brace a line with a lateral brace. Follow the procedure below to install and brace a dead leg.

Step 1. Install a tee in the main or cross main at the point where longitudinal bracing is required.

Step 2. Cut a length of pipe with a diameter equal to or greater than the diameter of the main being longitudinally braced.

Step 3. Cap one end of the pipe using proper solvent welding technique. (See section on "Joining CPVC Pipe and Fittings with One-Step Solvent Cement.")

Step 4. Solvent weld the pipe to the tee perpendicular to the main being longitudinally braced.

Step 5. Attach a lateral sway brace designed for use with CPVC pipe to the dead leg. The sway brace must be no greater than 24 in. from the center line of the main.

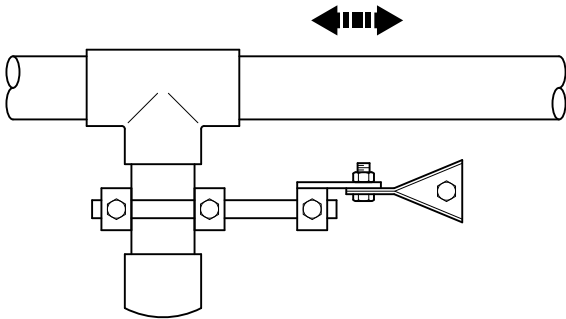

CHEMICAL COMPATIBILITY

NOTICE

Products coming in contact with CPVC systems must be chemically compatible. Products commonly used in construction, including materials ancillary to the assembly of fire sprinkler systems, may contain chemicals that are incompatible with CPVC, including but not limited to: hydrocarbons (for example, non-CPVC compatible cutting oils), termiticides and insecticides, surfactants, cooking oils, plasticizers (for example, flexible wire or hose), building caulks, and certain paints. This list is not meant to be exhaustive. Contact between CPVC and incompatible chemicals should be avoided; failure to avoid contact with incompatible chemicals may cause damage to/failure of the system. Consult The Lubrizol Corporation's FBC SYSTEM COMPATIBLE PROGRAM at www.fbcssystemcompatible.com. If the product in question is not identified in the FBC SYSTEM COMPATIBLE PROGRAM, Lubrizol recommends, as does IPEX, that the chemical compatibility be confirmed with the manufacturer of the product in question. IPEX does not provide a warranty for products or components which have been subject to deterioration from exposure to incompatible chemicals/materials.

NOTICE

PAINT

The Listings and Approvals do not cover any (to be installed or existing) painted CPVC fire sprinkler products.

Water-based acrylic latex paint is the preferred and recommended paint to be used on IPEX CPVC Pipe and Fittings. OIL OR SOLVENT-BASED PAINTS MAY BE CHEMICALLY INCOMPATIBLE WITH IPEX CPVC.

The installation contractor must take responsibility for obtaining approval from the authority having jurisdiction to cover the markings on the product (for example, product identification, listing marks) and to change color of the pipe and fittings from its identifiable orange. Application of oil or solvent-based paints must be individually reviewed, as there are certain types of paints and stains that contain drying oils and should not be used at all on CPVC. Contact the manufacturer of the paint for verification of compatibility of paints other than water-based acrylic latex.

Storage - Pipe & Fittings

IPEX CPVC Pipe and Fittings can be stored in their original packaging to keep them free from dirt and reduce the possibility of damage. IPEX pipe (un-packaged) must be covered with a non-transparent material when stored outdoors for extended periods of time. Brief exposure to direct sunlight on the job site may result in color fade, but will not affect physical properties. Long term exposure to direct sunlight will increase color fading and can make the pipe and fittings more brittle. Avoid long term exposure to ultra-violet light and/or direct sun exposure.

When storing inside, IPEX CPVC Pipe and Fittings should be kept in a well ventilated area, away from steam lines or other types of heat sources. IPEX CPVC Pipe and Fittings should always be stored in the original packaging until needed for use to keep them free from dirt and other contaminants, eliminate color fading, and reduce the possibility of damage.

Pipe should be stored on a clean, flat surface that provides an even support for the entire length of the pipe. When palletized pipe is stored, ensure that the wooden pallet bracings are in full contact with each other. Loose pipe should be stored in original packaging. When storing pipe on racks, the racks should have continuous or close support arms to prevent the pipe from sagging. Pipe racks should be free of oil/dirt and sharp edges that can damage the pipe when stored.

Plastic pipe fittings should be stored on pallets in their original cartons. The cartons should then be wrapped with thin plastic sheeting to prevent moisture from causing the packaging to collapse. To avoid hydrocarbon contamination and failure of the CPVC fittings under pressure, IPEX CPVC Fittings should never be stored with metal fittings.

Special care shall be taken to avoid contamination of IPEX CPVC Pipe and Fittings. (See Notice located on Page 57, Chemical Compatibility section)

Handling - Solvent Cements

⚠ CAUTION

Prior to using CPVC solvent cements, review and follow all precautions found on the container labels, material safety data sheet, and Standard Practice for Safe Handling ASTM F 402. Failure to follow precautions may result in injury.

Cements contain volatile solvents that evaporate rapidly. Avoid breathing the vapors and provide ventilation. If necessary, use a fan to keep the work area clear of fumes. Avoid skin contact. Keep the cement can closed when not in use. If the cement thickens beyond its original consistency, discard it. Do not attempt to dilute it with primer or thinner, as this may change the character of the cement and make it ineffective. Primers and thinners may also not be compatible with the IPEX CPVC and could cause failures. (See Notice located on Page 57, Chemical Compatibility section)

Before applying solvent cement, appropriate safety precautions should be taken. Cement must be stored between 40°F (4,4°C) and 90°F (32,2°C) and should be kept in the shade. Eliminate all ignition sources and do not smoke when using. Explosion proof general mechanical ventilation or local exhaust is recommended to maintain vapor concentrations below recommended exposure limits. In confined or partially enclosed areas, a NIOSH approved organic vapor cartridge respirator with full face piece is recommended. Containers of solvent cement should be closed when not

in use. Wearing PVA coated protection gloves and an impervious apron are recommended. Splash proof chemical goggles are recommended. For further information refer to Technical Data Sheet IFP-2010 SDS (Safety Data Sheet) for TFP-600 or BM-5 One Step Solvent Cement.

Note: *IPEX Blazemaster solvent cement has an expiration date of two years after the date of manufacture which is printed on the container.*

Storage - Solvent Cements

Cement must be stored between 40°F (4,4°C) and 90°F (32,2°C) and should be kept in the shade. Eliminate all ignition sources.

Solvent - Cement Spills

The best protection from accidental spills of cement is to protect the work area with drop cloths. If cement comes in contact with fiberglass tub/shower enclosures, carpet or furniture, the excess cement must be wiped up immediately. Once the cement is dry, it is almost impossible to remove.

The use of solvents such as alcohol, M.E.K. or acetone will usually work on tile sinks or floors but can do more damage than good on some synthetic materials. Care should be used when trying any solvent to remove cement from any surface. Always protect the work area before starting, both under and around where cement spills can cause irreparable damage.

Whatever method is used, it should first be tested on a small hidden area, if it removes the shine or color or softens the surface, do not use.

JOINING CPVC PIPE AND FITTINGS WITH ONE-STEP SOLVENT CEMENT

NOTICE

Read and understand all instructions prior to assembly. Follow all instructions. Failure to follow instructions during joining and testing may result in pipe failure, clogged waterways, or leakage.

Solvent cementing is the only method of joining rigid CPVC pipe and fittings that provides a chemically fused joint. Solvent cementing procedures must be carefully followed. Field experience has shown that problems can occur with improperly solvent cemented joints. Follow the instructions presented below carefully. Do not omit any steps and ensure that all facets of installation are fully understood prior to commencing work. Note the specific instructions and cure times for the TFP-600 or BM-5 One Step Solvent Cement provided within this handbook. These instructions and cure times must be carefully followed. TFP offers a demonstration program for installers that is described on Page 5 of this handbook.

NOTICE

Use of solvent cement products other than TFP-600 or BM-5 One Step Solvent Cement will void IPEX's warranty on IPEX CPVC Pipe and Fittings.

Avoid applying too much cement. Do not allow the cement to drip beyond the bottom of fitting socket. Do not allow the cement to puddle in the pipe and fitting assembly. Excessive cement on the pipe and/or fitting can weaken the wall of the pipe and/or fitting and may cause cracks

when pressure is applied. Failure to comply could result in property damage due to leaks. Leaks may not appear until after the pipe and/or fitting is in service.

Estimating Cement Requirements

Guidelines to allow estimation of IPEX CPVC Cement quantities needed are provided in Table T.

Table T – Estimated Cement Requirements

Fitting Size ANSI Inch DN	3/4 DN20	1 DN25	1 1/4 DN32	1 1/2 DN40	2 DN50	2 1/2 DN65	3 DN80
One Step Solvent Cemented Joints per Quart	260	170	125	95	65	40	30



Cutting Pipe



De-burring and
Beveling Pipe End



Clean & Fit Pipe & Fitting



Apply Solvent Cement
to Pipe End



Apply Solvent Cement
to Fitting



Assemble Pipe and
Fitting

Cutting

CPVC can easily be cut with a ratchet cutter, a wheel-type plastic tubing cutter, a power saw or a fine toothed saw. Tools used to cut CPVC must be designed for plastic use and must be in good condition in accordance with the tool manufacturer's recommendations. It is important to cut the pipe square. A square cut provides the surface of the pipe with maximum bonding area.

NOTICE

Avoid splitting the pipe when using ratchet cutters. Failure to do so may result in pipe failure or leakage.

- Only use ratchet cutters that contain a sharp blade (blades dull quickly).
- Only use ratchet cutters at temperatures of 50°F (10°C) or warmer.
- Only use well-maintained, good quality ratchet cutters capable of consistently cutting the pipe squarely.

If any indication of damage or cracking is evident at the pipe end, cut off at least 2 in. (50 mm) beyond any visible crack.

De-burring and Beveling

Burrs and filings can prevent proper contact between pipe and fitting during assembly, and must be removed from the outside and the inside of the pipe. A chamfering/reaming tool or a file is suitable for this purpose. A slight bevel (approximately 10° to 15° by 1/8 in. to 3/32 in.) shall be made at the end of the pipe along the outer diameter to ease entry of the pipe into the socket. This will also minimize the chance that the edges of the pipe will wipe solvent cement from the fitting socket during the insertion of the pipe.

Solvent Cement Application

⚠ CAUTION

Prior to using TFP-600 or BM-5 One Step Solvent Cement, review and follow all precautions found on the container labels, Safety Data Sheet, and Standard Practice for Safe Handling ASTM F 402. Failure to follow precautions may result in injury.

Using a clean, dry rag, wipe loose dirt and moisture from the fitting socket and pipe end. Moisture can slow the cure time and at this stage of assembly, and excessive water can reduce joint strength.

The pipe should easily enter the fitting socket one-third to two-thirds of the way. Contact between the pipe and fitting is essential in making a good joint. This contact allows the solvent cement (which is applied in the next step) to effectively join the pipe and fitting.

Use a dauber that is properly sized for the pipe. For 3/4 in. (DN20) and 1 in. (DN25) pipe, use a dauber that is 3/4 in. (19,1 mm) in size. For 1 1/4 in. (DN32) through 3 in. (DN80) pipe, use a dauber that is 1 1/2 in. (38,1 mm) in size.

Pint cans are furnished with 3/4 in. (DN20) daubers. Quart cans are furnished with 1 1/2 in. (38,1 mm) daubers. Additional daubers can be obtained through Customer Service.

All solvent cement joints shall be made with TFP-600 or BM-5 One Step Solvent Cement, as applicable (see LISTINGS/APPROVALS).

Apply a heavy, even coat of cement to the outer wall of the pipe end. Apply a medium coat to the inside of the fitting socket. Pipe sizes 1 1/4 in. (DN32) and above shall always receive a second cement application. **FIRST APPLY CEMENT ON THE PIPE END, THEN IN THE FITTING SOCKET, AND, FINALLY, ON THE PIPE END AGAIN.**

NOTICE

Too much solvent cement can cause clogged waterways or weaken the wall of the pipe or fitting and result in pipe failure or leakage, which may not appear until after the pipe and/or fitting is in service.

- *Do not allow excess cement to puddle in the pipe and fitting assembly. To prevent this puddling, apply a lighter coating of solvent cement to the inside of the fitting socket than the outside of the pipe.*
- *Wipe off excess cement on the outside of the joint. The solvents will evaporate, but the solvent cement inside the fitting will stay there.*

Special care shall be exercised when assembling CPVC fire sprinkler systems in temperatures below 40°F (4°C). In colder temperatures extra time must be allowed for the solvent cement to set and cure. Extra care should be taken to prevent damaging the pipe during handling. (See Notice located on Page 59, Handling - Pipe and Fittings section.) When solvent cementing pipe and fittings in colder temperatures, make certain that the cement has not become lumpy or has not "gelled". Gelled cement must be discarded.

At temperatures above 80°F (27°C) make sure both surfaces to be joined are still wet with cement during assembly. Higher temperatures and/or wind accelerate the evaporation of the volatile solvents in the cement. Pipe stored in direct sunlight may have surface temperatures 20°F to 30°F (-7°C to -1°C) above the air temperature. If possible, store the pipe and fittings, or, at least the ends to be solvent welded, out of the direct sunlight prior to cementing. The solvents will penetrate hot surfaces more deeply. In such conditions, it is very important to avoid puddling the solvent cement inside the fitting socket.

Assembly

After applying cement, immediately insert the pipe into the fitting socket, while rotating the pipe one-quarter turn until the pipe bottoms out at the fitting stop. Rotate the pipe as it is inserted into the fitting, not after it has bottomed out in the fitting. Properly align the fitting for the installation at this time. Pipe must bottom to the stop. Hold the assembly for 30 seconds to ensure initial bonding. **A bead of solvent cement should be evident around the pipe and fitting juncture. If this bead is not continuous around the socket shoulder, it may indicate that insufficient cement was applied.** If insufficient cement is applied, the fitting must be cut out and discarded. Cement in excess of the bead should be wiped off with a clean, dry rag.

NOTICE

Failure to allow sprinkler fitting joints to cure before installing sprinklers may result in cement in the sprinkler waterway.

- *Install sprinklers only after all the CPVC pipe and fittings, including the sprinkler adapters, are solvent cemented and allowed to cure for a minimum of 30 minutes.*
- *Do not install sprinklers in the fittings prior to the fittings being cemented in place.*

Exercise care when installing sprinklers. Allow sprinkler head fittings and previously joined fittings to cure for a minimum of 30 minutes prior to installing the sprinkler. When installing sprinklers, be sure to anchor or hold the pipe drop securely to avoid rotating the pipe in previously cemented connections.

NOTICE

Too much solvent cement can cause clogged waterways.

- *Visually inspect sprinkler fittings to ensure that the waterway and threads are clear of any excess cement.*
- *Once the installation is complete and cured per Table U, V or W, hydrostatically test the system.*

Set and Cure Times

NOTICE

Inadequate curing of solvent cement joints may cause pipe failure or leakage. Solvent cement set and cure times are a function of pipe size, temperature, relative humidity, and tightness of fit.

Cure times should be increased when moisture is present, such as during cut-ins to live sprinkler lines. (NOTE: A specific procedure for modifications or repairs to existing CPVC fire sprinkler lines is included in this manual.) The assembly must be allowed to set, without any stress on the joint, for 1 to 5 minutes, depending on pipe size and temperature. Following the initial set period, the assembly can be handled carefully, **avoiding significant stresses to the joint.**

See Tables U, V, and W for minimum cure times prior to pressure testing.

System Acceptance Testing (Hydrostatic Pressure Test)

⚠ WARNING

Never use compressed air or nitrogen in lieu of or to replace the required hydrostatic system acceptance testing. Any pre-testing performed with low pressure air or nitrogen should follow the recommendations on Page 67. System failure when using high-pressure compressed air or nitrogen may result in property damage, serious injury, or death.

Once an installation is completed and joints are properly cured per the above instructions, the system shall be pressure tested with water at 200 psi (13,8 bar) for 2 hours. See Table V for curing conditions at 200 psi (13,8 bar).

TFP-600 or BM-5 Solvent Cement Cure Times

Table U

Nominal Pipe Size ANSI Inches DN	Ambient Temperature Ranges During Cure Period		
	60°F to 120°F (16°C to 49°C)	40°F to 59°F (4°C to 15°C)	0°F to 39°F (-18°C to 3°C)
	Minimum Cure Times for Systems Requiring Pressure Testing up to 100 psi (6,9 bar)		
3/4 / DN20	15 minutes	15 minutes	30 minutes
1 / DN25	15 minutes	30 minutes	30 minutes
1 1/4 / DN32	15 minutes	30 minutes	2 hours

Table V

Nominal Pipe Size ANSI Inches DN	Ambient Temperature Ranges During Cure Period		
	60°F to 120°F (16°C to 49°C)	40°F to 59°F (4°C to 15°C)	0°F to 39°F (-18°C to 3°C)
	Minimum Cure Times for Systems Requiring Pressure Testing up to 200 psi (13,8 bar)		
3/4 / DN20	45 minutes	1-1/2 hours	24 hours
1 / DN25	45 minutes	1-1/2 hours	24 hours
1 1/4 / DN32	1-1/2 hours	16 hours	120 hours
1 1/2 / DN40	1-1/2 hours	16 hours	120 hours
2 / DN50	6 hours	36 hours	*
2 1/2 / DN65	8 hours	72 hours	*
3 / DN80	8 hours	72 hours	*

Table W

Nominal Pipe Size ANSI Inches DN	Ambient Temperature Ranges During Cure Period		
	60°F to 120°F (16°C to 49°C)	40°F to 59°F (4°C to 15°C)	0°F to 39°F (-18°C to 3°C)
	Minimum Cure Times for Systems Requiring Pressure Testing up to 225 psi (15,5 bar)		
3/4 / DN20	1 hour	4 hours	72 hours
1 / DN25	1-1/2 hours	4 hours	72 hours
1 1/4 / DN32	3 hours	32 hours	10 days
1 1/2 / DN40	3 hours	32 hours	10 days
2 / DN50	8 hours	48 hours	*
2 1/2 / DN65	24 hours	96 hours	*
3 / DN80	24 hours	96 hours	*

* For this size pipe and fitting, the solvent cement can be applied at temperatures below 40°F (4,4°C), however, the sprinkler system temperature must be raised to a temperature of 40°F (4,4°C) or above and allowed to cure per the requirements listed above prior to pressure testing.

The system shall be pressure tested with water at 50 psi (3,4 bar) in excess of maximum pressure when the maximum system pressure is to be maintained in excess of 150 psi (10,3 bar). See Table W for curing conditions at 225 psi (15,5 bar). This requirement is in accordance with the requirements established by NFPA Standard 13, Section 24.2.1 (2013 Edition).

Sprinkler systems in one- and two-family dwellings and mobile homes may be pressure tested with water at line pressure, after following Table U curing conditions, in accordance with the requirements established by NFPA 13D, Section 4.3 (2013 Edition).

In systems featuring RSA adapter fittings and where hydrostatic testing is required by the Authority Having Jurisdiction prior to sprinkler installation, sprinkler adapter outlets may be plugged with RSA system test plugs during testing. Remove the plugs and replace with sprinklers after successful testing.

When pressure testing, the sprinkler system shall be slowly filled with water and the air bled from the highest and farthest sprinklers before pressure testing begins. Air must be removed from piping systems (plastic or metal) to prevent it from being locked in the system when pressure is applied. Entrapped air can generate excessive surge pressures that can result in bodily injury and/or property damage, regardless of the piping materials used.

If a leak is found, the leaking pipe and/or fitting must be cut out and discarded. A new section of piping can be installed using couplings or a union. Unions should be used in accessible areas only.

Limited Pressurized Air or Nitrogen Testing Allowance

⚠ WARNING

Extreme caution must be exercised when applying pressurized air or nitrogen to BLAZEMASTER CPVC systems. System failure caused by high-pressure compressed air or nitrogen can cause property damage, severe personal injury, or death.

If it is necessary to pre-test a BLAZEMASTER CPVC piping system with air or nitrogen prior to the required hydrostatic test, the following recommendations must be followed:

1. Maximum pressure (air or nitrogen) must never exceed 5 psig (35 kPa) and must be regulated using the appropriate air maintenance device.
2. Air or nitrogen introduced into the system must not contain oils, lubricants, or other chemicals. Use an oil-less compressor. (Information regarding chemical and substance compatibility with BLAZEMASTER CPVC can be found at www.fbcssystemcompatible.com.)
3. Proper use of Personal Protective Equipment (PPE), including but not limited to safety glasses, hard hats, and protective gloves, must be worn while performing any air test. Prior to pressurization and for the duration of the test, all personnel must be evacuated from the test area.

Note: This recommendation applies only when the pre-testing of a system has been deemed necessary. Pre-testing with low pressure air or nitrogen is not a substitute for hydrostatic testing, which is required by the installation standard (i.e., NFPA).

JOINING PIPE AND FITTINGS IN ADVERSE CONDITIONS

In Cold Weather

TFP-600 or BM-5 One Step Solvent Cement is suitable for joining IPEX CPVC Pipe and Fittings during cold weather temperatures as low as 0°F (-18°C) minimum (assembly in temperatures below 0°F (-18°C) are not permitted). The time period for bonding CPVC pipe and fittings is affected by temperature; therefore, very cold weather requires extra time to cure cemented joints.

When assembling a CPVC pipe and fitting system requiring pressure testing at 225 psi (15,5 bar) (See Table W) and the Ambient Temperature is less than 0°F (-18°C), the CPVC pipe and fittings must be conditioned in a freezer at 0°F (-18°C) for 24 hours prior to assembly. Immediately after the 24 hour conditioning period, join the pipe and fittings with TFP-600 or BM-5 One Step Solvent Cement in the 0°F (-18°C) environment and allow to cure per Table W before pressure testing.

Very cold weather will make IPEX CPVC Pipe and Fittings brittle. Extra care should be taken during such conditions to prevent damage while handling, cutting, de-burring, beveling, and assembly.

NOTICE

Extra care must be exercised if using ratchet cutters as they may split the pipe if not properly used and maintained. See Cutting section on Page 63.

When working in cold weather, be aware that solvents formulated into TFP-600 or BM-5 cement penetrate and soften the CPVC surfaces more slowly than in warm weather. Colder temperatures require greater cure times due to the slower evaporation of primer in solvent cements. See Tables U, V and W for cure times at various temperature ranges.

Other considerations are required when preparing for and joining CPVC pipe and fittings in cold weather conditions:

1. Carefully read and follow all instructions before installation.
2. Prefabricate as much of the system as possible in a heated working area.
3. Store cements in a warm area when not in use and make sure they remain fluid. Do not allow the cement to freeze or become "jelly-like." Gelled cement shall be discarded.
4. Take special care to remove moisture, including ice and snow.
5. When using TFP-600 or BM-5 One Step Solvent Cement, primer shall never be used.
6. Allow a longer cure period before the system is used.

In Hot Weather

CPVC solvent cements contain volatile solvents. Higher temperatures and/or wind accelerate evaporation. Pipe stored in direct sunlight may have surface temperatures of 20°F to 30°F (-7°C to -1°C) above air temperatures. Solvents attack these hot surfaces deeper; therefore, it is very important to avoid puddling the cement inside the fitting socket. Always ensure that the excess cement is wiped from the outside of the joint.

Follow the standard installation instructions and take special note of the tips and cautions below:

1. See Tables G1 & G2 for the appropriate temperature related expansion and contraction information.
2. Store solvent/cements and primers in a cool or shaded area prior to use.
3. If possible, store pipe and fittings, or at least the ends to be solvent welded, in a shady area before cementing.
4. Make sure both surfaces to be joined are still wet with cement when putting them together. With larger size pipe more people may be required to complete the application successfully.
5. Carefully read and follow all instructions before installation.

TRANSITION TO OTHER MATERIALS

Male and female brass insert thread adapters, grooved pipe adapters, or flanges shall be used when connecting a IPEX system to other piping materials. Special brass insert threaded fittings or the Rapid Seal Adapter (RSA) series are used for connection to sprinklers.

When IPEX CPVC Pipe and Fittings are used in combination systems with steel pipe, compliance with 2013 NFPA 13 sections 6.3.7 and 6.4.3, and 2013 NFPA 13R sections 5.2.3 and 5.2.12.2 is required.

The instructions for transitioning to other materials are specifically for IPEX CPVC Fittings. Should other Listed BLAZEMASTER CPVC Fittings be used in conjunction with IPEX CPVC products, consult the fitting manufacturer's installation and design manuals.

NOTICE

Care must be taken when transition is made to dissimilar materials. Brass inserts used in male and female threaded and grooved CPVC adapters may create galvanic reaction with steel and iron drop nipples, pipe, and cast fittings in certain water conditions. If you are unsure of the potential for galvanic reaction to occur, verify the water condition and conductivity of the water being used in the sprinkler system piping prior to installation. Brass threaded nipples are recommended when using brass inserted threaded IPEX CPVC Fittings to reduce the potential of galvanic reaction caused by dissimilar metals.

Care must be taken when transition is made from metallic pipe, fittings and flanges. When transitioning from metallic pipe system to a IPEX CPVC piping system via grooved adapter, male or female thread adapter or flanges, caution must be taken to ensure that all hydrocarbons and/or cutting oils are thoroughly removed from both inside and outside of the metallic pipe, fittings and flanges prior to assembly with IPEX CPVC Pipe and Fittings. (See Notice located on Page 57, Chemical Compatibility section.)

Brass Threaded Connections

A thread sealant shall be used in making wrench-tightened NPT threaded connections. TEFLON thread tape is the recommended sealant. Some thread sealants other than TEFLON thread tape contain solvents or other materials that may be damaging to CPVC. For other types of thread sealants, which have been specifically investigated and confirmed to be "System Compatible," refer to the FBC System Compatible Program at www.fbcssystemcompatible.com, Underwriters Laboratory and FM Global Approvals.

Note: *The use of any other thread sealant may result in damage to the IPEX CPVC and/or the brass insert. DO NOT use a combination of tape and thread sealant on the same joint.*

When using TEFLON thread tape, IPEX recommends a thickness of 0.003 in. (3 mils) \pm 0.0005 in. and the tape must meet or exceed military specification MIL-T-27730A. The tape should be wrapped in the direction of the threads. Generally 2 to 3 wraps are sufficient to obtain a leak free seal.

When using OATEY GREAT WHITE Thread Sealant, it should be applied to the male threads only. Make sure all the threads are covered and DO NOT clog the waterway with excess sealant.

Care must be taken to avoid over-torquing. Usually 1 to 2 turns beyond finger tight is all that is required to make up a threaded connection. For sprinkler torque requirements refer to the appropriate sprinkler technical data sheets.

NOTICE

A hold back device, approved for use with CPVC pipe and fittings, must be used when torquing the body of the sprinkler adapter. Failure to so may result in damage to the brass threaded connector and void the TFPP warranty. Additionally, the CPVC system may also fail or leak, resulting in property damage.

Sprinkler Installation in Rapid Seal Adapter (RSA) Fittings

Install sprinklers in RSA Fittings in accordance with the following procedure.

Refer to individual sprinkler data sheets for additional information including required sprinkler wrenches.

NOTICE

For assembly of CPVC piping and fittings, see Tables on Page 66 and Joining Pipe and Fittings in Adverse Conditions section on Page 68 for Curing Time.

⚠ CAUTION

DO NOT apply thread sealant or TEFLON thread tape on sprinklers intended to be installed in RSA Fittings. Thread Sealant or TEFLON tape may not allow the sprinkler to seat properly and cause leakage and/or equipment failure.

Step 1. Ensure the sprinkler threads are clean and do not have thread sealant such as tape or paste applied. Avoiding cross-threading, gently thread the sprinkler into the fitting and hand-tighten until the sprinkler makes contact with the gasket.

⚠ CAUTION

Do not over-torque sprinklers when wrench-tightening with the manufacturer required sprinkler wrench. Over-torquing may result in equipment damage.

For recessed applications do not attempt to compensate for insufficient sprinkler depth within the Escutcheon Plate by under- or over-tightening the sprinkler. Re-adjust the sprinkler fitting position to suit.

Step 2. Adjust orientation of the sprinkler by applying the manufacturer specified sprinkler wrench to the sprinkler wrench flats and wrench-tighten an additional 1/2 to 1 full turn, or by applying a minimum-to-maximum torque of 5 to 7 ft lb (6,8 to 9,5 N·m).

Gasket Replacement in Rapid Seal Adapter (RSA) Fittings

NOTICE

Gasket Replacement and its associated tools were not evaluated as part of the UL Listing program.

In the event that a sprinkler, installed in an RSA fitting longer than six months, is removed due to damage or activation, the RSA fitting or the RSA fitting gasket must be replaced.

See Appendix A for separately ordered replacement gaskets and tools.

Step 1. Remove the sprinkler from the RSA fitting.

⚠ CAUTION

Use caution when removing the gasket to avoid damaging the adapter threads. Failure to do so may result in equipment damage or failure.

Step 2. Using the Rapid Seal Gasket Removal Pick, (see Figure 2) carefully remove the gasket from the RSA fitting. Discard the old gasket.

Step 3. Verify that the RSA fitting port is clean - free of all debris, chips, or burrs. Failure to do so may result in equipment damage or failure.

Step 4. Ensure the tool Base Socket is the correct size, 1 1/4 in. socket or 1 1/2 in. socket, for the RSA fitting.

Note: *To change the Base Socket, remove two socket head cap screws using a 3/16 in. hex head wrench.*

Step 5. Rotate the Rapid Seal Gasket Replacement Tool insertion shaft (see Figure 3) counter-clockwise until fully retracted. Place the Rapid Seal Replacement Gasket (see Figure 4) onto the shaft end boss and rotate the shaft clockwise until the gasket is flush with the surface of the base recess.

Step 6. Holding the Rapid Seal Gasket Replacement Tool (see Figure 3) base recess firmly against the face of the RSA fitting, rotate the insertion shaft until fully engaged. Remove the Rapid Seal Gasket Replacement Tool from the RSA and verify that the gasket is evenly seated and fully installed in the RSA fitting port.

Step 7. Install the replacement sprinkler in accordance with the Sprinkler Installation section in this handbook.

Grooved Coupling Adapter Connections

The following procedures are recommended for proper assembly of the Grooved Coupling Adapter:

Inspect the fittings and pipe to ensure that they are sufficiently free of indentations, projections or roll-marks on the gasket seating areas of the fitting and pipe. The pipe should be squarely cut. Any loose scale, paint and/or dirt must be removed from the groove and seating surfaces prior to assembly.

Flexible couplings shall be used with grooved coupling adapters in wet pipe systems. Refer to flexible coupling manufacturer's technical data sheets for additional information. Use a standard grade EPDM-A gasket that is suitable for wet pipe fire sprinkler service, see manufacturer's temperature ratings.

Flexible couplings shall be used with grooved coupling adapters in dry pipe systems. Refer to flexible coupling manufacturer's Technical Data Sheets for additional information. Use a standard grade EPDM-A or EPDM-E gasket that is suitable for dry pipe fire sprinkler service. Dry pipe systems require an external lubricant, see Notice below.

NOTICE

For dry pipe and freezer applications, the addition of a petroleum free silicone lubricant is required.

Products coming in contact with CPVC systems (for example, coupling gaskets, coupling lubricants) must be chemically compatible. (See Notice located on Page 57, Chemical Compatibility section.) Use of rigid style couplings may damage the grooved coupling adapter. Consult the grooved coupling manufacturer for proper selection and installation instructions.

Use of petroleum based lubricants will damage the gasket and may damage the adapter, resulting in stress failure of the CPVC housing that could cause property damage.

PENETRATING FIRE RATED WALLS & PARTITIONS

Consult the authority having jurisdiction and building codes prior to penetrating fire rated walls and partitions. Several through-penetration firestop systems are UL listed for use with CPVC pipe. IPEX recommends BLAZEMASTER Caulk and Walk for use with IPEX CPVC Pipe and Fittings, as this caulking product contains a water based intumescent that will not harm the CPVC compound as verified by The Lubrizol Corporation. The use of fire-stopping materials incompatible with IPEX CPVC Pipe and Fittings may cause damage to and/or failure of the CPVC system. (See Notice located on Page 57, Chemical Compatibility section.)

IPEX CPVC piping systems shall be designed and installed so that the piping is not closely located to heat producing sources, such as light fixtures, ballasts and steam lines. Pipe must not be positioned directly over open ventilation grills. Finally, during periods of remodeling or ceiling repair, appropriate steps must be taken to shield the piping from the protected occupancy.

Because IPEX CPVC Pipe is more flexible than metallic sprinkler pipe, it has greater capacity to withstand earthquake damage. In areas subject to earthquakes, IPEX CPVC piping systems should be designed and braced in accordance with local codes and NFPA Standard 13. For information regarding Bending Deflections and Snaking Deflections for given lengths of CPVC SDR 13.5 pipe, See Tables N1, N2, P1, and P2.

Use extreme care when passing IPEX CPVC Pipe and Fittings through metal studs, as the sharp cut edges of these studs can scar or puncture thermoplastic pipe. IPEX recommends the use of chemically compatible rubber or plastic grommets such as those commonly used in the plumbing industry for protection of the pipe when passing through such spaces. Consult your local authority having jurisdiction for additional information regarding the protection of thermoplastic pipe when passed through metal studs. (See Notice located on Page 57, Chemical Compatibility section.)

FREEZE PROTECTION

Use of Dry Type Sprinklers

When dry type sprinklers are connected to a water filled IPEX CPVC piping system protecting areas subject to freezing temperature, consideration must be given to the appropriate length of the sprinkler that will prevent freezing of the water in the connecting pipes due to conduction, as well as the compatibility of the fitting to which the dry type sprinkler will be attached. Refer to the sprinkler manufacturers' installation instructions for specific guidance on the minimum recommended lengths between the face of the sprinkler fitting and the outside surface of the protected area, as well as the appropriate fitting types for use with dry type sprinklers.

Use and Cautions with UL Listed Antifreeze or Glycerin Antifreeze

IPEX CPVC Pipe and other Listed IPEX CPVC Fittings can be protected with UL Listed Antifreeze only as outlined by NFPA 13 in areas that are subject to freezing. The guidelines provided in this manual must be followed when providing freeze protection for IPEX CPVC Pipe and Fittings. UL Listed Antifreeze is the first UL Certified (Listed) antifreeze for use in CPVC systems.

When adequate freeze protection cannot be attained with antifreeze, IPEX CPVC systems are recommended to be protected by using batt insulation and building construction techniques that ensure adequate freeze protection and wind blocking. Batt insulation guidelines are provided by most local authorities having jurisdiction with recommendations for NFPA 13D installations provided in the Appendix of that Standard. Local building code and authorities having jurisdiction requirements must be followed carefully, as misplaced or inadequate insulation and wind blocking can create localized freeze of the system piping that can result in damage to the structure and piping system. When adequate insulation and wind blocking are not available, IPEX CPVC Pipe and other Listed IPEX CPVC Fittings can be protected with LFP® Antifreeze or Glycerin antifreeze solutions only as outlined by NFPA 13 in areas that are subject to freezing. The guidelines provided below must be followed when providing freeze protection for IPEX CPVC Pipe and Fittings.

NOTICE

Products coming in contact with CPVC systems (for example, anti-freeze, alcohol based cleaners) must be chemically compatible. (See Notice located on Page 57, Chemical Compatibility section.)

- The use of glycol based antifreeze solutions is specifically prohibited for use with IPEX CPVC systems.
- Prior to using Glycerin Antifreeze, consult the local authority having jurisdiction on the use of antifreeze solutions in fire sprinkler applications.
- Prior to using Glycerin antifreeze solutions, consult the NFPA 13 standard for rules and guidelines.
- If hydro testing the sprinkler system, ensure that the system is completely drained of water prior to introducing LFP® Antifreeze or Glycerin antifreeze. The antifreeze solution will not fully mix with trapped water in sprinkler drops and sprinkler system low points, potentially allowing freezing in these areas of the system.
- A Glycerin antifreeze sprinkler system is more prone to leakage than a water only sprinkler system. Glycerin characteristics increase the capacity for leakage and can be successfully addressed by using care when making threaded connections by ensuring sufficient torque is applied to the male and female threads being mated.

A thread sealant shall be used in making threaded connections. TEFLON thread tape is the recommended sealant. Some thread sealants other than TEFLON thread tape contain solvents or other materials that may be damaging to CPVC. For other types of thread sealants, which have been specifically investigated and confirmed to be "System Compatible," refer to the FBC System Compatible Program at www.fbcssystemcompatible.com.

IPEX recommends between 14 to 21 lb-ft (19,0 to 28,5 N-m) of torque to achieve a leak free 1/2 in. (DN15) NPT seal. Do not use fittings or sprinklers with damaged threads in glycerin systems, as the damaged threads create increased leakage potential. Rapid Seal Adapter fittings are not to be used with a thread sealant. The manufacturer instructions should be followed to obtain a good seal to prevent leaking in Rapid Seal Adapter fittings.

- Glycerin antifreeze can be cleaned with alcohol based cleaners. Prior to using any cleaner on a surface, ensure compatibility with the surface material to be cleaned. If compatibility with the surface to be cleaned is questionable, a small section of the surface should be spot cleaned prior to wide spread application of the cleaner.

Batt Insulation Requirements and Suggestions

Many jurisdictions recommend the use of batt insulation for freeze protection in place of antifreeze solutions. These jurisdictions typically publish recommended batt insulation guidelines that provide the minimum thickness of insulation to be utilized. These minimum insulation recommendations should be followed. Insulation requirements may vary by geographic area given climate conditions. Batt insulation is used to maintain a minimum water temperature in the sprinkler piping of 40°F (4,4°C). The minimum insulation recommendations pictured in the Appendix of NFPA 13D are shown primarily for piping wood frame ceilings with an unheated attic or an un-insulated roof above. Many jurisdictions do not allow the installation of water filled sprinkler piping in unheated outside walls. Consult the local authority having jurisdiction prior to installing batt insulation for freeze protection with BLAZEMASTER CPVC products.

NOTICE

Products coming in contact with CPVC systems (for example, insulation) must be chemically compatible. (See Notice located on Page 57, Chemical Compatibility section.)

Batt Insulation Installation Recommendations

The 2007 edition of NFPA 13D, The Standard for the Installation of Sprinkler Systems in One and Two-Family Dwellings and Manufactured Homes, Appendix A.8.3.1 recommends the following guidelines for use of batt insulation:

In areas subject to freezing, care should be taken to cover sprinkler piping completely in unheated attic spaces with insulation. Installation should follow the guidelines of the insulation manufacturer. (Figures A.8.3.1 (a) through (e) show several installation methods that can be considered.)

- A.8.3.1 (a) "It is important that the insulation be installed tight against the joists. In unheated areas, any spaces or voids between the insulation and the joists causes the water in the fire sprinkler piping to freeze."
- A.8.3.1 (b) "For areas having temperatures of 0°F (-18°C) or lower, an additional batt of insulation covering the joist and the fire sprinkler piping should be used. If this is not done, localized freeze-ups can occur in the sprinkler piping."
- A.8.3.1 (c) "Boring holes in the joist is one of the methods for locating the fire sprinkler piping in the ceiling. As an alternative, when temperatures are expected to be 0°F (-18°C) or lower, loose pieces of insulation should be stuffed in the bored holes around the piping."
- A.8.3.1 (d) (e) "Care should be taken to avoid compressing the insulation. This reduces its R value. To prevent potential freeze-ups of the sprinkler piping, the insulation should be tight against the joists."

Minimum insulation R value requirements are typically between R19 and R30; however, the minimum requirements must be verified with the authority having jurisdiction.

CUT-IN PROCEDURE FOR SYSTEM MODIFICATION AND REPAIR

At times it may become necessary to make modifications to existing CPVC fire sprinkler systems. Cut-ins can be done safely when the proper procedures are followed. The following procedure has been developed to assure that the modifications are done successfully.

Prior to making cut-ins to existing systems, care should be used to review proper joining procedures and to follow cut-in cure schedules (Tables U, V and W) to ensure system integrity. Several methods can be utilized to tie into an existing system using a socket style tee fitting in combination with the use of socket unions, grooved coupling adapters, and flanges. Regardless of the method used, the following points must be followed to ensure system integrity:

- Using proper tools, the cut-in should be made on the smallest diameter pipe section (that is capable of adequately supplying the system changes) in close proximity to the modification being made. This approach will expedite cure times prior to pressure testing.
- The cut-in connection to the existing system should be made first, prior to proceeding with additional work.

- Existing lines must be drained adequately prior to solvent cementing. Use a Drain Vac unit to be sure all water is removed from the system. Moisture can slow the cure time and will reduce joint strength.
- Carefully review and follow the solvent cementing procedures for proper joining techniques prior to commencing the cut-in (pipe must be cut square to proper length, de-burred, beveled and dry to ensure proper insertion depth and system integrity).
- Carefully measure and cut pipe to proper length to ensure complete insertion during assembly (first check the interference fit of the components being joined).

Note: *During assembly of the cut-in tee (and other components), it is important to make a one-quarter turn when inserting the pipe into the fitting per the installation instructions. This may require the use of several components assembled in combination with the cut-in tee to create a short spool piece assembly. This can be accomplished by using socket unions, flanges, or grooved coupling adapters that will ensure that a one-quarter turn can be obtained on all pipe connections being joined.*

- Prior to applying the solvent cement, use a clean dry rag to wipe moisture and dirt from the fitting socket and the pipe end (the presence of moisture on the joining surfaces will reduce joint integrity).
- Use a new can of solvent cement when making cut-in connections (verify expiration dates stamped on can prior to use).
- After all work is completed, the cut-in joints must be allowed to cure properly prior to pressure testing as shown in the Tables U, V, and W.
- After work is completed and the cut-in cure times are met, inspect work for proper alignment and hanger placement prior to pressure testing.
- After cut-in cure times are met, the system must be slowly filled with water and the air bled from the farthest and highest sprinklers before test pressure is applied. (See instructions regarding pressure testing the system.)
- After cut-in cure times are met and the air is bled from the system, pressure testing of the portion of the sprinkler system containing the cut-in tee is recommended. Prior to pressure testing, the system must be isolated off to its smallest area using floor valves, etc., to isolate the cut-in area. Additionally, the recommended test pressure to be applied is a maximum of 50 psi (3,4 bar) over the system operating pressure. Should a leak occur, this approach will minimize the potential for water damage.

- When tying into a IPEX CPVC piping system that has been painted with water based latex paint, the paint on the end of the piping should be removed with a fine grain sand paper approximately 1/4 in. to 1/2 in. (6,4 mm to 12,7 mm) beyond the make-in of the fitting being added. Care should be exercised to assure that material is evenly removed from the entire circumference of the piping. The outside diameter of the piping should be measured and compared to Tables D1 and D2. If too much material is removed at one location along the circumference, it could result in a leak point once the fitting is solvent welded to the piping. Special care should be made when selecting the fitting that will be attached to the recently cleaned piping. Check the dry fit of the pipe and fitting. The pipe should enter the fitting socket easily 1/4 to 3/4 of the way. If the pipe bottoms in the fittings with little interference, select a different fitting. All other criteria outlined in "Installation- Cut-In Procedure for System Modification and Repair" should be followed to assure system integrity.

ASTM CPVC FITTING SOCKET DIMENSIONS U.S. UNITS

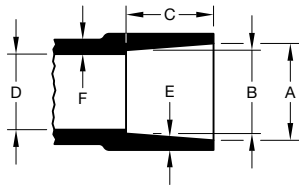

Nominal Pipe Size ANSI Inches	Nominal Inches					
	A Socket Entrance Diameter	B Socket Bottom Diameter	C Minimum Socket Depth	D Minimum Inside Diameter	Minimum Wall Thicknesses	
					E	F
3/4	1.058	1.046	0.719	0.740	0.113	0.141
1	1.325	1.310	0.875	0.990	0.133	0.166
1 1/4	1.670	1.655	0.938	1.335	0.140	0.175
1 1/2	1.912	1.894	1.375	1.446	0.220	0.250
2	2.387	2.369	1.500	1.881	0.218	0.275
2 1/2	2.889	2.868	1.750	2.250	0.276	0.345
3	3.516	3.492	1.875	2.820	0.300	0.375

ASTM CPVC FITTING SOCKET DIMENSIONS METRIC UNITS

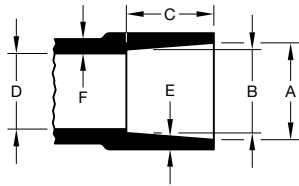

Nominal Pipe Size DN	Nominal Millimeters					
	A Socket Entrance Diameter	B Socket Bottom Diameter	C Minimum Socket Depth	D Minimum Inside Diameter	Minimum Wall Thicknesses	
					E	F
DN20	26,88	26,60	18,30	18,80	2,90	3,60
DN25	33,70	33,30	22,23	25,15	3,40	4,22
DN32	42,42	42,04	23,82	33,91	3,60	4,50
DN40	48,60	48,11	34,93	36,73	5,60	6,40
DN50	60,63	60,20	38,10	47,80	5,54	7,00
DN65	73,40	72,90	44,45	57,20	7,00	8,80
DN80	89,31	88,70	47,63	71,63	7,62	9,53

TEE

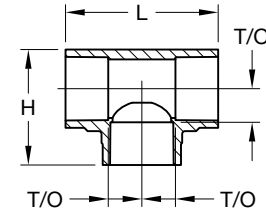

Nominal Pipe Size ANSI Inches DN	Nominal Take-Out Inches (mm)	Nominal outside Inches (mm)		Pipe Sch.	Approx. Wt. Lbs. (kg.)	P/N
		L	H			
1 DN25	0.687 (17,4)	3.180 (80,8)	2.405 (61,1)	40	0.19 (0,09)	048081
1 1/4 DN32	0.875 (22,2)	3.750 (95,3)	2.875 (73,0)	40	0.26 (0,11)	048082
1 1/2 DN40	1.062 (27,0)	4.900 (124,5)	3.625 (92,1)	80	0.51 (0,23)	048083
2 DN50	1.375 (34,9)	5.900 (149,9)	4.380 (111,3)	80	0.90 (0,41)	048084
2 1/2 DN65	1.562 (39,7)	6.730 (170,9)	5.110 (129,8)	80	1.59 (0,72)	048085
3 DN80	1.812 (46,0)	7.500 (190,5)	5.830 (148,1)	80	2.41 (1,09)	048086

REDUCING TEE – 1 of 2

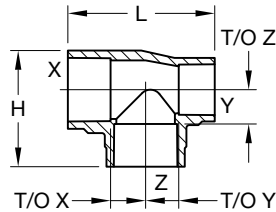

Nominal Pipe Size ANSI Inches DN			Nominal Take-Out Inches (mm)			Nominal Outside Inches (mm)		Pipe Sch.	Approx. Wt. Lbs. (kg.)	P/N
X	Y	Z	X	Y	Z	L	H			
3/4 DN20	3/4 DN20	1 DN25	0.750 (19,0)	0.750 (19,0)	0.625 (15,9)	2.890 (73,4)	2.140 (54,4)	40	0.14 (0,06)	048121
1 DN25	3/4 DN20	3/4 DN20	0.562 (14,3)	0.562 (14,3)	0.750 (19,0)	2.790 (70,9)	2.295 (58,3)	40	0.14 (0,06)	048122
1 DN25	3/4 DN20	1 DN25	0.750 (19,0)	0.687 (17,4)	0.750 (19,0)	3.060 (77,7)	2.415 (61,3)	40	0.17 (0,07)	048123
1 DN25	1 DN25	3/4 DN20	0.625 (15,9)	0.625 (15,9)	0.812 (20,6)	3.120 (79,2)	2.375 (60,3)	40	0.16 (0,07)	048160
1 1/4 DN32	1 DN25	3/4 DN20	0.625 (15,9)	0.625 (15,9)	0.937 (23,8)	3.330 (84,6)	2.705 (68,7)	40	0.21 (0,09)	048124
1 1/4 DN32	1 DN25	1 DN25	0.750 (19,0)	0.750 (19,0)	0.937 (23,8)	3.300 (83,8)	2.785 (70,7)	40	0.22 (0,09)	048125
1 1/4 DN32	1 DN25	1-1/4 DN32	0.937 (23,8)	0.937 (23,8)	0.875 (22,2)	3.640 (92,5)	2.795 (71,0)	40	0.26 (0,11)	048126
1 1/4 DN32	1-1/4 DN32	3/4 DN20	0.625 (15,9)	0.625 (15,9)	0.875 (22,2)	3.240 (82,3)	2.685 (68,2)	40	0.23 (0,10)	048161
1 1/4 DN32	1-1/4 DN32	1 DN25	0.750 (19,0)	0.750 (19,0)	0.875 (22,2)	3.500 (88,9)	2.825 (71,8)	40	0.26 (0,11)	048162
1 1/4 DN32	1-1/4 DN32	1-1/2 DN40	1.000 (25,4)	1.000 (25,4)	1.000 (25,4)	4.700 (119,4)	3.515 (89,3)	80	0.43 (0,19)	048127
1 1/2 DN40	1-1/4 DN32	3/4 DN20	0.562 (14,3)	0.562 (14,3)	1.000 (25,4)	3.920 (99,6)	3.255 (82,7)	80	0.36 (0,16)	048128
1 1/2 DN40	1-1/4 DN32	1 DN25	0.562 (14,3)	0.562 (14,3)	1.062 (27,0)	3.920 (99,6)	3.435 (87,2)	80	0.38 (0,17)	048129
1 1/2 DN40	1-1/2 DN40	3/4 DN20	0.562 (14,3)	0.562 (14,3)	1.000 (25,4)	4.040 (102,6)	3.255 (82,7)	80	0.36 (0,16)	048163

REDUCING TEE – 2 of 2

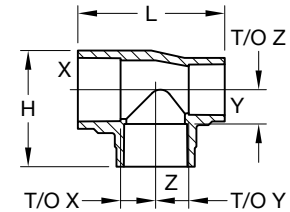

Nominal Pipe Size ANSI Inches DN			Nominal Take-Out Inches (mm)			Nominal Outside Inches (mm)		Pipe Sch.	Approx. Wt. Lbs. (kg.)	P/N
X	Y	Z	X	Y	Z	L	H			
1 1/2 DN40	1-1/2 DN40	1 DN25	0.562 (14,3)	0.562 (14,3)	1.062 (27,0)	4.040 (102,6)	3.445 (87,5)	80	0.38 (0,17)	048164
1 1/2 DN40	1-1/2 DN40	1-1/4 DN32	0.875 (22,2)	0.875 (22,2)	1.000 (25,4)	4.640 (117,9)	3.505 (89,0)	80	0.45 (0,20)	048175
2 DN50	2 DN50	3/4 DN2	0.750 (19,0)	0.750 (19,0)	1.375 (34,9)	4.580 (116,3)	3.880 (98,6)	80	0.61 (0,28)	048165
2 DN50	2 DN50	1 DN25	0.875 (22,2)	0.875 (22,2)	1.375 (34,9)	4.830 (122,7)	4.010 (101,9)	80	0.66 (0,30)	048166
2 DN50	2 DN50	1-1/4 DN32	1.125 (28,6)	1.125 (28,6)	1.375 (34,9)	5.190 (131,8)	4.150 (105,4)	80	0.74 (0,33)	048174
2 DN50	2 DN50	1-1/2 DN40	0.750 (19,0)	0.687 (17,4)	0.750 (19,0)	5.400 (137,2)	4.240 (107,7)	80	0.78 (0,35)	048167
2 1/2 DN65	2-1/2 DN65	1 DN25	1.562 (39,7)	1.562 (39,7)	1.562 (39,7)	6.730 (170,9)	4.480 (113,8)	80	1.43 (0,65)	048171
2 1/2 DN65	2-1/2 DN65	1-1/4 DN32	1.562 (39,7)	1.562 (39,7)	1.562 (39,7)	6.730 (170,9)	4.680 (118,9)	80	1.46 (0,66)	048172
2 1/2 DN65	2-1/2 DN65	1-1/2 DN40	1.562 (39,7)	1.562 (39,7)	1.562 (39,7)	6.730 (170,9)	4.710 (119,6)	80	1.48 (0,67)	048173
2 1/2 DN65	2-1/2 DN65	2 DN50	1.562 (39,7)	1.562 (39,7)	1.562 (39,7)	6.730 (170,9)	4.870 (123,7)	80	1.50 (0,68)	048176
3 DN80	3 DN80	1-1/2 DN40	1.812 (46,0)	1.812 (46,0)	1.812 (46,0)	7.520 (191,0)	5.330 (135,4)	80	2.28 (1,03)	048170
3 DN80	3 DN80	2 DN50	1.812 (46,0)	1.812 (46,0)	1.750 (44,4)	7.500 (190,5)	5.440 (138,2)	80	2.25 (1,02)	048168
3 DN80	3 DN80	2-1/2 DN65	1.812 (46,0)	1.812 (46,0)	1.812 (46,0)	7.520 (191,0)	5.710 (145,0)	80	2.44 (1,11)	048169

CROSS

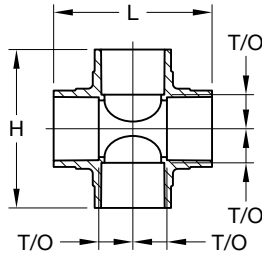

Nominal Pipe Size ANSI Inches DN	Nominal Take-Out Inches (mm)	Nominal Outside Inches (mm)		Pipe Sch.	Approx. Wt. Lbs. (kg.)	P/N
		L	H			
3/4 DN20	0.562 (14,3)	2.750 (69,9)	2.750 (69,9)	40	0.13 (0,06)	048087
1 DN25	0.687 (17,4)	3.300 (83,2)	3.300 (83,2)	40	0.23 (0,10)	048088
1 1/4 DN32	0.937 (23,8)	3.750 (95,3)	3.750 (95,3)	40	0.34 (0,15)	048089
1 1/2 DN40	1.062 (27,0)	4.900 (124,5)	4.900 (124,5)	80	0.67 (0,30)	048090
2 DN50	1.312 (33,3)	5.720 (145,3)	5.720 (145,3)	80	1.00 (0,45)	048091
2 1/2 DN65	1.562 (39,7)	6.750 (171,5)	6.750 (171,5)	80	1.91 (0,87)	048092

REDUCING CROSS

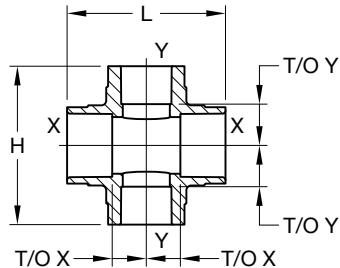

Nominal Pipe Size ANSI Inches DN		Nominal Take-Out Inches (mm)		Nominal Outside Inches (mm)		Pipe Sch.	Approx. Wt. Lbs. (kg.)	P/N
X	Y	X	Y	L	H			
1 DN25	3/4 DN20	0.875 (22,2)	0.875 (22,2)	3.300 (83,8)	3.300 (83,8)	40	0.28 (0,13)	048093

90° ELBOW

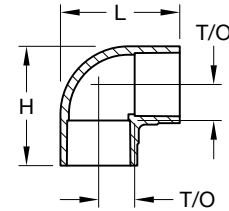

Nominal Pipe Size ANSI Inches DN	Nominal Take-Out Inches (mm)	Nominal Outside Inches (mm)		Pipe Sch.	Approx. Wt. Lbs. (kg.)	P/N
		L	H			
3/4 DN20	0.625 (15,9)	2.090 (53,1)	2.090 (53,1)	40	0.09 (0,04)	049094
1 DN25	0.750 (19,0)	2.495 (63,4)	2.495 (63,4)	40	0.14 (0,06)	048095
1 1/4 DN32	1.000 (25,4)	2.945 (74,8)	2.945 (74,8)	40	0.21 (0,09)	048096
1 1/2 DN40	1.062 (27,0)	3.625 (92,1)	3.625 (92,1)	80	0.40 (0,18)	048097
2 DN50	1.312 (33,3)	4.325 (109,9)	4.325 (109,9)	80	0.79 (0,36)	048098
2 1/2 DN65	1.562 (39,7)	5.080 (129,0)	5.080 (129,0)	80	1.14 (0,52)	048099
3 DN80	1.812 (46,0)	5.825 (148,0)	5.825 (148,0)	80	1.82 (0,82)	048100

90° REDUCING ELBOW

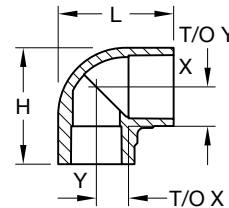

Nominal Pipe Size ANSI Inches DN		Nominal Take-Out Inches (mm)		Nominal Outside Inches (mm)		Pipe Sch.	Approx. Wt. Lbs. (kg.)	P/N
X	Y	X	Y	L	H			
1 DN25	3/4 DN20	0.687 (17,4)	1.812 (46,0)	2.435 (61,8)	2.435 (61,8)	40	0.16 (0,07)	048101

45° ELBOW

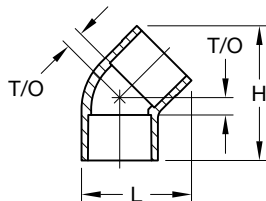

Nominal Pipe Size ANSI Inches DN	Nominal Take-Out Inches (mm)	Nominal Outside Inches (mm)		Pipe Sch.	Approx. Wt. Lbs. (kg.)	P/N
		L	H			
3/4 DN20	0.375 (9,5)	1.926 (48,9)	2.434 (61,8)	40	0.08 (0,04)	048102
1 DN25	0.375 (9,5)	2.284 (58,0)	2.799 (71,1)	40	0.11 (0,05)	048103
1 1/4 DN32	0.750 (19,0)	2.971 (75,5)	3.831 (97,3)	40	0.20 (0,09)	048104
1 1/2 DN40	0.500 (12,7)	3.318 (84,3)	4.047 (102,8)	80	0.31 (0,14)	048105
2 DN50	0.750 (19,0)	4.041 (102,6)	4.959 (126,0)	80	0.56 (0,25)	048106
2 1/2 DN65	1.812 (46,0)	4.846 (123,1)	5.713 (145,1)	80	0.89 (0,40)	048207
3 DN80	1.000 (25,4)	5.648 (143,5)	6.505 (165,2)	80	1.19 (0,54)	048208

COUPLING

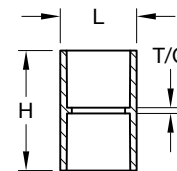

Nominal Pipe Size ANSI Inches DN	Nominal Take-Out Inches (mm)	Nominal Outside Inches (mm)		Pipe Sch.	Approx. Wt. Lbs. (kg.)	P/N
		L	H			
3/4 DN20	0.125 (3,2)	1.280 (32,5)	2.120 (53,8)	40	0.08 (0,04)	048107
1 DN25	0.125 (3,2)	1.590 (40,4)	2.500 (63,5)	40	0.11 (0,05)	048108
1 1/4 DN32	0.187 (4,7)	1.950 (49,5)	2.190 (55,6)	40	0.20 (0,09)	048109
1 1/2 DN40	0.500 (12,7)	2.310 (58,7)	3.080 (78,2)	80	0.31 (0,14)	048110
2 DN50	0.750 (19,0)	2.820 (71,6)	3.310 (84,1)	80	0.56 (0,25)	048111
2 1/2 DN65	0.812 (20,6)	3.440 (87,4)	3.850 (97,8)	80	0.89 (0,40)	048112
3 DN80	1.000 (25,4)	4.120 (104,6)	4.250 (108,0)	80	1.19 (0,54)	048113

REDUCING COUPLING

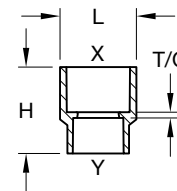

Nominal Pipe Size ANSI Inches DN		Nominal Take-Out Inches (mm)	Nominal Outside Inches (mm)		Pipe Sch.	Approx. Wt. Lbs. (kg.)	P/N
X	Y		L	H			
1 DN25	3/4 DN20	0.125 (3,2)	1.590 (40,4)	1.800 (45,7)	40	0.08 (0,04)	048149

REDUCING BUSHING

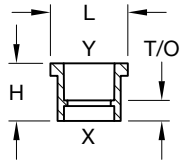

Nominal Pipe Size ANSI Inches DN		Nominal Take-Out Inches (mm)	Nominal Outside Inches (mm)		Pipe Sch.	Approx. Wt. Lbs. (kg.)	P/N
X	Y		L	H			
1 DN25	3/4 DN20	0.437 (11,1)	1.490 (37,8)	1.200 (30,5)	40	0.04 (0,06)	048182
1 1/4 DN32	3/4 DN20	0.500 (12,7)	1.840 (46,7)	1.260 (32,0)	40	0.11 (0,05)	048183
1 1/4 DN32	1 DN25	0.312 (7,9)	1.840 (46,7)	1.260 (32,0)	40	0.12 (0,05)	048184
1 1/2 DN40	3/4 DN20	0.625 (15,9)	2.090 (53,1)	1.670 (42,4)	80	0.16 (0,07)	048185
1 1/2 DN40	1 DN25	0.500 (12,7)	2.090 (53,1)	1.670 (42,4)	80	0.14 (0,06)	048186
1 1/2 DN40	1-1/4 DN32	0.375 (9,5)	2.090 (53,1)	1.670 (42,4)	80	0.17 (0,08)	048187
2 DN50	3/4 DN20	0.812 (20,6)	2.600 (66,0)	1.870 (47,5)	80	0.27 (0,12)	048188
2 DN50	1 DN25	0.687 (17,4)	2.600 (66,0)	1.870 (47,5)	80	0.26 (0,12)	048189
2 DN50	1-1/4 DN32	0.562 (14,3)	2.600 (66,0)	1.870 (47,5)	80	0.24 (0,11)	048190
2 DN50	1-1/2 DN40	0.437 (11,1)	2.600 (66,0)	1.870 (47,5)	80	0.19 (0,11)	048191
2 1/2 DN65	1 DN25	0.937 (23,8)	3.110 (79,0)	2.130 (54,1)	80	0.42 (0,19)	048197
2 1/2 DN65	1-1/4 DN32	0.812 (20,6)	3.110 (79,0)	2.140 (54,4)	80	0.45 (0,20)	048196
2 1/2 DN65	1-1/2 DN40	0.687 (17,4)	3.110 (79,0)	2.140 (54,4)	80	0.46 (0,21)	048195
2 1/2 DN65	2 DN50	0.625 (15,9)	3.110 (79,0)	2.140 (54,4)	80	0.29 (0,13)	048193
3 DN80	2 DN50	0.750 (19,0)	3.760 (95,5)	2.330 (59,2)	80	0.72 (0,33)	048192
3 DN80	2-1/2 DN65	0.500 (12,7)	3.760 (95,5)	2.330 (59,2)	80	0.47 (0,21)	048194

CAP

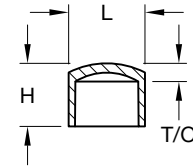

Nominal Pipe Size ANSI Inches DN	Nominal Take-Out Inches (mm)	Nominal Outside Inches (mm)		Pipe Sch.	Approx. Wt. Lbs. (kg.)	P/N
		L	H			
3/4 DN20	0.312 (7,9)	1.280 (32,5)	1.100 (27,9)	40	0.04 (0,02)	048114
1 DN25	0.375 (9,5)	1.590 (40,4)	1.314 (33,4)	40	0.06 (0,03)	048115
1 1/4 DN32	0.437 (11,1)	1.950 (49,5)	1.760 (44,7)	40	0.10 (0,04)	048116
1 1/2 DN40	0.687 (17,4)	2.310 (58,7)	2.192 (55,7)	80	0.20 (0,09)	048117
2 DN50	0.687 (17,4)	2.820 (71,6)	2.230 (56,6)	80	0.31 (0,14)	048118
2 1/2 DN65	0.875 (22,2)	3.440 (87,4)	2.770 (70,4)	80	0.58 (0,26)	048119
3 DN80	1.000 (25,4)	4.120 (104,6)	3.000 (76,2)	80	0.88 (0,40)	048120

SPRINKLER ADAPTER 90° ELBOW

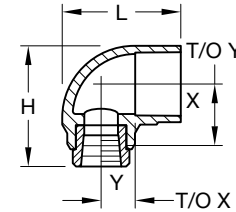

Nominal Pipe Size ANSI Inches DN	Thread Size Inch NPT	Nominal Take-Out Inches (mm)		Nominal Outside Inches (mm)		Pipe Sch.	Approx. Wt. Lbs. (kg.)	P/N
		X	Y	L	H			
3/4 DN20	1/2	0.562 (14,3)	1.000 (25,4)	2.040 (51,8)	2.160 (54,9)	40	0.20 (0,09)	048148
1 DN25	1/2	0.750 (19,0)	1.250 (31,7)	2.470 (62,7)	2.515 (63,9)	40	0.26 (0,12)	048147
1 DN25	3/4	1.062 (27,0)	1.437 (36,5)	2.875 (73,0)	2.835 (72,0)	40	0.26 (0,12)	048146

GROOVED COUPLING ADAPTER

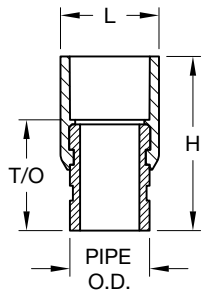

Nominal Pipe Size ANSI Inches DN		Nominal Take-Out & Pipe O.D. Inches (mm)		Nominal Outside Inches (mm)		Pipe Sch.	Approx. Wt. Lbs. (kg.)	P/N
		T/O	Pipe O.D.	L	H			
1 1/4 DN32	1-1/4 Groove	0.875 (22,2)	1.660 (42,4)	2.050 (52,1)	3.630 (92,2)	40	0.78 (0,35)	048137
1 1/2 DN40	1-1/2 Groove	1.125 (28,6)	1.900 (48,3)	2.310 (58,7)	3.740 (95,0)	80	0.95 (0,43)	048138
2 DN50	2 Groove	0.750 (19,0)	2.375 (60,3)	2.820 (71,6)	3.870 (98,3)	80	1.42 (0,64)	048139
2 1/2 DN65	2-1/2 Groove	1.562 (39,7)	2.875 (73,0)	3.440 (87,4)	4.220 (107,2)	80	2.28 (1,03)	048140
2 1/2 DN65	76,1mm Groove	1.562 (39,7)	76,1mm 3.000	3.600 (91,4)	4.220 (107,2)	80	2.28 (1,03)	048142
3 DN80	3 Groove	1.562 (39,7)	3.500 (88,9)	4.120 (104,6)	4.320 (109,7)	80	3.00 (1,36)	048141

SPRINKLER ADAPTER

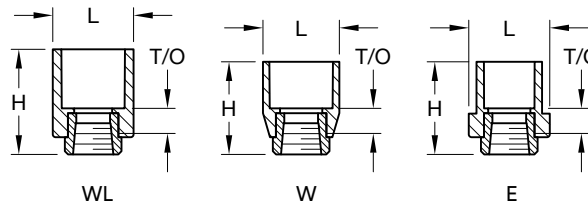

Nominal Pipe Size ANSI Inches DN	Thread Size Inch NPT	Nominal Take-Out Inches (mm)	Nominal Outside Inches (mm)		Pipe Sch.	Approx. Wt. Lbs. (kg.)	P/N
			L	H			
3/4 DN20	1/2	0.437 (11,1)	1.710 (43,4)	2.060 (52,3)	80	0.20 (0,09)	048178
1 DN25	1/2	0.437 (11,1)	1.710 (43,4)	2.190 (55,6)	80	0.22 (0,10)	048179
3/4 DN20	1/2	0.437 (11,1)	1.280 (32,5)	1.740 (44,2)	40	0.16 (0,07)	048223
1 DN25	3/4	0.812 (20,6)	1.590 (40,4)	2.500 (63,5)	40	0.43 (0,19)	048144
3/4 DN20	1/2	0.500 (12,7)	1.600 (40,6)	1.720 (43,7)	40	0.19 (0,09)	048222
1 DN25	1/2	0.500 (12,7)	1.590 (40,4)	1.930 (49,0)	40	0.18 (0,08)	048180

SPRINKLER ADAPTER (SPIGOT)

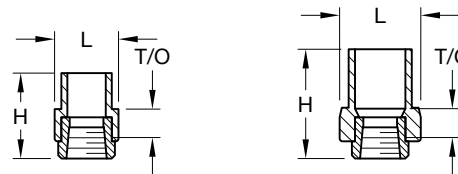

X (Not LPCB Approved)

Nominal Pipe Size ANSI Inches DN	Thread Size Inch NPT	Nominal Take-Out Inches (mm)	Nominal Outside Inches (mm)		Pipe Sch.	Approx. Wt. Lbs. (kg.)	P/N
			L	H			
3/4 DN20	1/2	0.500 (12,7)	1.330 (33,8)	1.780 (45,2)	40	0.16 (0,07)	048177
1 DN25	1/2	0.562 (14,3)	1.720 (43,7)	1.920 (48,8)	40	0.20 (0,09)	048143
1 DN25	3/4	0.875 (22,2)	1.750 (44,5)	2.240 (56,9)	40	0.40 (0,18)	048145
1 DN25	1/2	0.625 (15,9)	1.720 (43,7)	2.268 (57,6)	40	0.20 (0,09)	048181

FEMALE ADAPTER

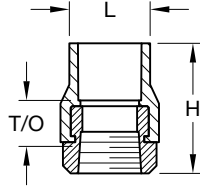

Nominal Pipe Size ANSI Inches DN	Thread Size Inch NPT	Nominal Take-Out Inches (mm)	Nominal Outside Inches (mm)		Pipe Sch.	Approx. Wt. Lbs. (kg.)	P/N
			L	H			
3/4 DN20	3/4	0.812 (20,6)	1.710 (43,4)	2.390 (60,7)	80	0.41 (0,19)	048130
1 DN25	1	0.875 (22,2)	2.050 (52,1)	2.710 (68,8)	80	0.63 (0,28)	048131
1 1/4 DN32	1-1/4	1.125 (28,6)	2.390 (60,7)	3.100 (78,7)	40	1.03 (0,47)	048132
1 1/2 DN40	1-1/2	1.375 (34,9)	2.650 (67,3)	3.440 (87,4)	80	1.42 (0,64)	048133
2 DN50	2	1.687 (42,8)	3.480 (88,4)	3.950 (100,3)	80	2.66 (1,18)	048134

MALE ADAPTER

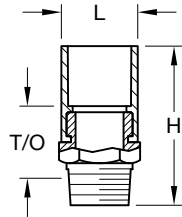

Nominal Pipe Size ANSI Inches DN	Thread Size Inch NPT	Nominal Take-Out Inches (mm)	Nominal Outside Inches (mm)		Pipe Sch.	Approx. Wt. Lbs. (kg.)	P/N
			L	H			
3/4 DN20	3/4 NPT	1.312 (33,3)	1.375 (34,9)	2.850 (72,4)	40	0.33 (0,15)	048135
1 DN25	1 NPT	1.375 (34,9)	1.690 (42,9)	3.320 (84,3)	40	0.56 (0,25)	048136

SPRINKLER ADAPTER TEE

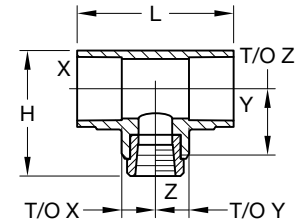

Nominal Pipe Size ANSI Inches DN			Nominal Take-Out Inches (mm)			Nominal Outside Inches (mm)		Pipe Sch.	Approx. Wt. Lbs. (kg.)	P/N
X	Y	Z	X	Y	Z	L	H			
3/4 DN20	3/4 DN20	1/2	0.562 (14,3)	0.562 (14,3)	1.000 (25,4)	2.700 (68,6)	2.139 (54,3)	40	0.22 (0,10)	048151
1 DN25	1 DN25	1/2	0.687 (17,4)	0.687 (17,4)	1.187 (30,1)	3.260 (82,8)	2.634 (66,9)	40	0.29 (0,13)	048152
1 DN25	1 DN25	1	0.937 (23,8)	0.937 (23,8)	1.562 (39,7)	3.680 (93,5)	3.005 (76,3)	40	0.73 (0,33)	048150
1 1/4 DN32	1 DN25	1/2	0.437 (11,1)	0.562 (14,3)	1.312 (33,3)	2.980 (75,7)	2.794 (71,0)	40	0.30 (0,14)	048156
1 1/4 DN32	1-1/4 DN32	1/2	0.437 (11,1)	0.437 (11,1)	1.312 (33,3)	3.000 (76,2)	2.794 (71,0)	40	0.31 (0,14)	048153
1 1/2 DN40	1-1/4 DN32	1/2	0.500 (12,7)	0.687 (17,4)	1.437 (36,5)	3.860 (98,0)	3.104 (78,8)	40	0.43 (0,19)	048157
1 1/2 DN40	1-1/2 DN40	1/2	0.500 (12,7)	0.500 (12,7)	1.437 (36,5)	3.860 (98,0)	3.104 (78,8)	80	0.46 (0,21)	048155
2 DN50	1-1/2 DN40	1/2	0.500 (12,7)	0.625 (15,9)	1.687 (42,8)	4.110 (104,4)	3.609 (91,7)	80	0.56 (0,25)	048158
2 DN50	2 DN50	1/2	0.500 (12,7)	0.500 (12,7)	1.687 (42,8)	4.100 (104,1)	3.599 (91,4)	80	0.62 (0,28)	048154

DRY SPRINKLER ADAPTER TEE

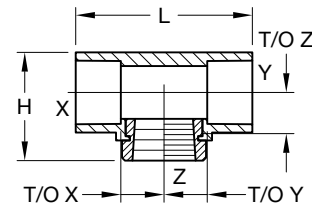

Nominal Pipe Size ANSI Inches DN			Nominal Take-Out Inches (mm)			Nominal Outside Inches (mm)		Pipe Sch.	Approx. Wt. Lbs. (kg.)	P/N
X	Y	Z	X	Y	Z	L	H			
1 DN25	1 DN25	1	0.90 (22,9)	0.90 (22,9)	0.86 (21,8)	3.680 (93,5)	2.255 (57,3)	40	0.71 (0,32)	048159

BACK TO BACK TEE

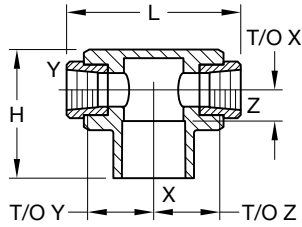

Nominal Pipe Size ANSI Inches DN	Thread Size Inch NPT			Nominal Take-Out Inches (mm)		Nominal Outside Inches (mm)		Pipe Sch.	Approx. Wt. Lbs. (kg.)	P/N
	X	Y	Z	X	Y Z	L	H			
1 DN25	1/2	1/2	0.562 (14,3)	1.312 (33,3)	3.628 (92,2)	2.700 (68,6)	40	0.48 (0,22)	048198	
1 DN25	1/2	1/2	0.687 (17,4)	1.187 (30,1)	3.358 (85,3)	2.700 (68,6)	40	0.46 (0,21)	048199	

BACK TO BACK CROSS

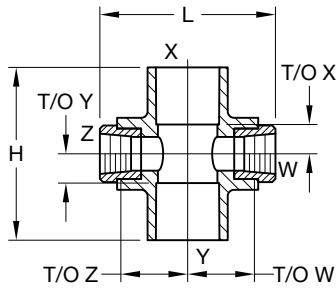

Nominal Pipe Size ANSI Inches DN	Thread Size Inch NPT				Nominal Take-Out Inches (mm)		Nominal Outside Inches (mm)		Pipe Sch.	Approx. Wt. Lbs. (kg.)	P/N
	X	Y	Z	W	X Y	Z W	L	H			
1 DN25	1 DN25	1/2	1/2	0.625 (15,9)	1.187 (30,1)	3.398 (86,3)	3.600 (91,4)	40	0.46 (0,21)	048200	
1 DN25	1 DN25	1/2	1/2	0.625 (15,9)	1.312 (33,3)	3.658 (92,9)	3.600 (91,4)	40	0.47 (0,21)	048201	

RAVEN STUDIO SPRINKLER ADAPTER 90° ELBOW

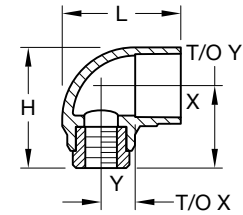

Nominal Pipe Size ANSI Inches DN	Thread Size ISO 228	Nominal Take-Out Inches (mm)		Nominal Outside Inches (mm)		Pipe Sch.	Approx. Wt. Lbs. (kg.)	P/N
		X	Y	L	H			
1 DN25	G3/8	0.750 (19,0)	1.750 (44,5)	2.470 (62,7)	2.535 (64,4)	40	0.26 (0,12)	048209

RAVEN STUDIO SPRINKLER ADAPTER TEE

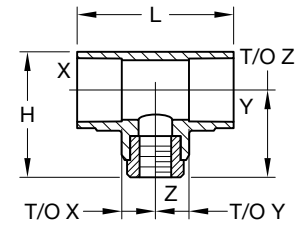

Nominal Pipe Size ANSI Inches DN	Thread Size ISO 228	Nominal Take-Out Inches (mm)			Nominal Outside Inches (mm)		Pipe Sch.	Approx. Wt. Lbs. (kg.)	P/N	
		X	Y	Z	L	H				
1 DN25	1 DN25	G3/8	0.687 (17,4)	0.687 (17,4)	1.625 (41,3)	3.260 (82,8)	2.634 (66,9)	40	0.29 (0,13)	048210

RAPID SEAL ADAPTER

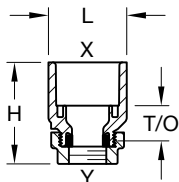

Nominal Pipe Size ANSI Inches DN	Thread Size Inch NPS	Nominal Take-Out Inches (mm)	Nominal Outside Inches (mm)		Pipe Sch.	Approx. Wt. Lbs. (kg.)	P/N
			L	H			
X	Y						
3/4 DN20	1/2	0.66 (16,8)	1.646 (41,8)	1.850 (47,0)	40	0.090 (0,041)	048211
1 DN25	1/2	0.78 (19,8)	1.630 (41,4)	2.140 (54,4)	40	0.107 (0,049)	048226

NOTE:

- Part Number 048211 is used for both the Rapid Seal Adapter and the Rapid Seal Adapter Spigot as it is a dual purpose fitting and can be used in two different applications.

RAPID SEAL ADAPTER SPIGOT

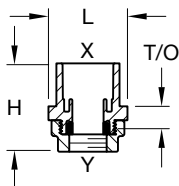

Nominal Pipe Size ANSI Inches DN	Thread Size Inch NPS	Nominal Take-Out Inches (mm)	Nominal Outside Inches (mm)		Pipe Sch.	Approx. Wt. Lbs. (kg.)	P/N
			L	H			
X	Y						
3/4 DN20	1/2	0.36 (9,1)	1.520 (38,6)	1.539 (39,1)	40	0.061 (0,028)	048227
1 DN25	1/2	0.51 (13,0)	1.646 (41,8)	1.850 (47,0)	40	0.090 (0,041)	048211

NOTE:

- Part Number 048211 is used for both the Rapid Seal Adapter and the Rapid Seal Adapter Spigot as it is a dual purpose fitting and can be used in two different applications.

RAPID SEAL ADAPTER 90° ELBOW

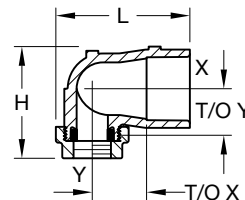

Nominal Pipe Size ANSI Inches DN	Thread Size Inch NPS	Nominal Take-Out Inches (mm)		Nominal Outside Inches (mm)		Pipe Sch.	Approx. Wt. Lbs. (kg.)	P/N
		X	Y	L	H			
X	Y	X	Y	L	H			
3/4 DN20	1/2	0.58 (14,8)	0.92 (23,4)	2.087 (53,0)	2.086 (53,0)	40	0.099 (0,045)	048215
1 DN25	1/2	1.13 (28,7)	1.01 (25,7)	2.789 (70,8)	2.327 (59,1)	40	0.148 (0,067)	048228

RAPID SEAL ADAPTER TEE

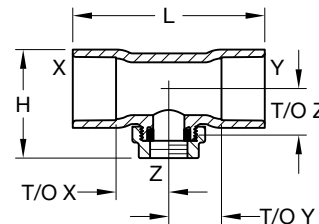

Nominal Pipe Size ANSI Inches DN	Thread Size Inch NPS	Nominal Take-Out Inches (mm)		Nominal Outside Inches (mm)		Pipe Sch.	Approx. Wt. Lbs. (kg.)	P/N
		X Y	Z	L	H			
X Y	Z	X Y	Z	L	H			
3/4 DN20	1/2	0.38 (9,7)	0.92 (23,4)	2.254 (57,3)	2.017 (51,2)	40	0.107 (0,049)	048230
1 DN25	1/2	1.10 (27,9)	1.01 (25,7)	4.000 (101,6)	2.261 (57,4)	40	0.205 (0,093)	048231

RAPID SEAL ADAPTER BACK TO BACK TEE

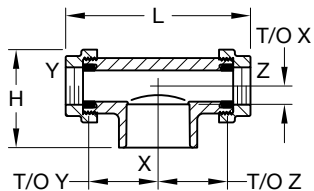

Nominal Pipe Size ANSI Inches DN	Thread Size Inch NPS	Nominal Take-Out Inches (mm)		Nominal Outside Inches (mm)		Pipe Sch.	Approx. Wt. Lbs. (kg.)	P/N
		X	Y Z	L	H			
1 DN25	1/2	0.38 (9,7)	1.37 (34,7)	3.645 (92,6)	2.042 (51,9)	40	0.190 (0,086)	048219
1 DN25	1/2	0.38 (9,7)	1.49 (37,9)	3.900 (99,1)	2.042 (51,9)	40	0.200 (0,091)	048218

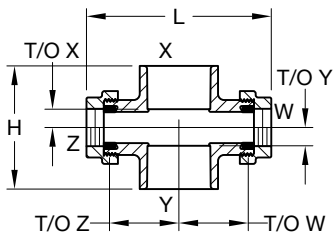

Nominal Pipe Size ANSI Inches DN	Thread Size Inch NPS	Nominal Take-Out Inches (mm)		Nominal Outside Inches (mm)		Pipe Sch.	Approx. Wt. Lbs. (kg.)	P/N
		X Y	W Z	L	H			
1 DN25	1/2	0.38 (9,7)	1.37 (34,7)	3.600 (91,4)	2.566 (65,2)	40	0.207 (0,094)	048220
1 DN25	1/2	0.38 (9,7)	1.49 (37,9)	3.850 (97,8)	2.566 (65,2)	40	0.217 (0,098)	048235

RAPID SEAL GASKET REPLACEMENT TOOL, P/N 074297

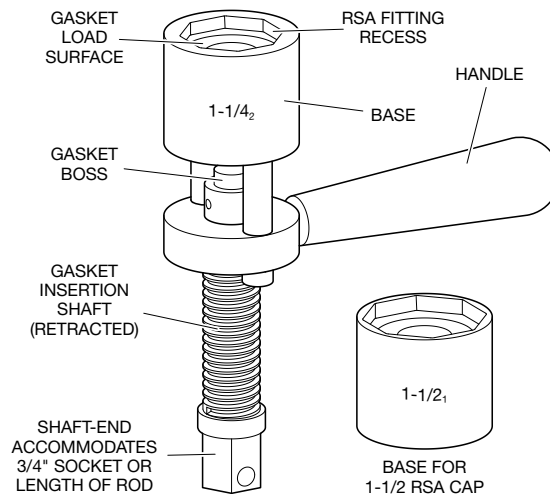

- Notes:
- 1-1/2 in. base used to replace gaskets in Version 1 adapters
 - 1-1/4 in. base used to replace gaskets in Version 2 adapters

RAPID SEAL
GASKET REMOVAL PICK, P/N 074294

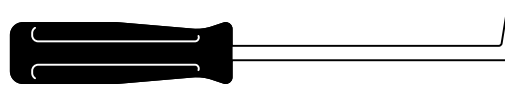

RAPID SEAL
REPLACEMENT GASKET (QTY 10), P/N 074295

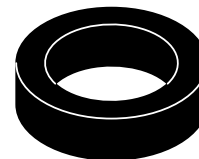

NOTICE

Gasket Replacement and its associated tools were not evaluated as part of the UL Listing program.

RAPID SEAL ADAPTER SYSTEM TEST PLUG, P/N 048224

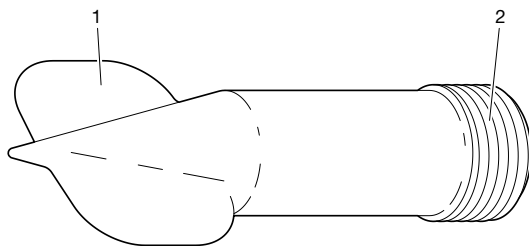

ITEM	DESCRIPTION
1	Thumb Tabs
2	Threads, 1/2 in. NPS

DO'S

- Install IPEX CPVC Pipe and Fittings according to this Installation Handbook.
- Follow recommended safe work practices.
- Make certain that any materials coming in contact with IPEX CPVC Pipe and Fittings are chemically compatible with BLAZEMASTER. (See Notice located on Page 57, Chemical Compatibility section.)
- If painting is required, use only latex based paints.
- Keep pipe and fittings in original packaging until needed and away from sources of heat.
- If stored outdoors, cover the pipe and fittings with an opaque tarp.
- Follow proper handling procedures.
- Inspect IPEX CPVC Pipe and Fittings for damage before installation.
- Use tools specifically designed for use with CPVC pipe and fittings.
- Use only TFP-600 or BM-5 One Step Solvent Cement and follow application instructions.
- Use a drop cloth to protect interior finishes.
- Cut the pipe ends square.
- Before solvent cementing, de-burr and bevel the pipe end.
- When solvent cementing, rotate the pipe 1/4 turn when bottoming pipe in fitting socket.
- Carefully follow instructions for applying solvent cement. Do not apply too much cement.
- Avoid puddling of solvent cement in pipe and fittings. Do not allow cement to plug the sprinkler adapter or sprinkler orifice.
- Follow the recommended cure times prior to pressure testing.
- Fill lines slowly and bleed the air from the system at the farthest sprinklers prior to pressure testing.
- Use water to pressure test the CPVC system. If low-pressure air or nitrogen pre-testing is deemed necessary, guidelines can be found on Page 67 of this installation manual and must be followed.
- Support sprinkler properly to prevent excessive movement of the sprinkler when activated.
- Install IPEX CPVC Pipe and Fittings in wet systems only or specially listed dry systems.
- Use only chemically compatible insulation and/or glycerin & water solutions for freeze protection.
- When glycerine solutions are used, provide an expansion chamber or allow for thermal expansion of the solution.
- Allow for movement due to expansion and contraction.
- Renew your IPEX CPVC Pipe and Fittings installation training every two years.

DON'TS

- Do not use cutting oils other than those represented by the cutting oil manufacturer as safe for use in conjunction with CPVC. (See Notice located on Page 57, Chemical Compatibility section.)
- Do not use edible oils such as CRISCO as a gasket lubricant.
- Do not use petroleum or solvent-based paints, sealants, lubricants or fire stop materials that are chemically incompatible with IPEX CPVC Pipe and Fittings.
- Do not use any glycol-based solutions as an antifreeze.
- Do not use glycerin-based antifreeze solutions without consulting the rules and guidelines outlined in the NFPA 13 Standard.
- Do not use both TEFLON tape and thread sealants simultaneously.
- Do not use TEFLON tape or thread sealants for Rapid Seal Adapter (RSA) sprinkler connection fittings.
- Do not use solvent cement that exceeds its shelf life or has become discolored or gelled.
- Do not allow threaded rod within 1/16 in. of the pipe.
- Do not allow solvent cement to plug the sprinkler orifice.
- Do not connect rigid metal couplers to IPEX CPVC grooved adapters.
- Do not thread or groove IPEX CPVC Pipe.
- Do not use solvent cement near sources of heat, open flame, or when smoking.
- Do not pressure test until recommended cure times are met.
- Do not use dull or broken cutting tool blades when cutting pipe.
- Do not use IPEX CPVC Pipe that has been stored outdoors, unprotected and is faded in color.
- Do not install IPEX CPVC Pipe in cold weather without allowing for expansion.
- Do not install IPEX CPVC Pipe and Fittings in dry systems, unless specifically listed for such use.

IMPORTANT INFORMATION WITH REGARDS TO BLAZEMASTER FIRE SPRINKLER SYSTEM

CONGRATULATIONS, your building structure contains a state-of-the-art life safety system. Your IPEX CPVC fire sprinkler system will enhance the safety and security of your building when properly maintained. IPEX CPVC Fire Sprinkler Products resist attack from a wide range of chemicals that are corrosive to metallic piping. As with any piping material, there are, however, certain chemicals that can be detrimental to CPVC. Occasionally some of these chemicals may be found in some construction products, site preparations and building maintenance. There are certain things that you need to be mindful of in caring for or working around your IPEX CPVC fire sprinkler system.

Keep your system clear from contact with the following products and chemicals unless product labels state materials are compatible with CPVC:

NOTICE	
Ordinary considerations	Property maintenance services
Cleaning Products Detergents, Oils/Lubricants/Greases, Rubbery Materials	Fungicides, Mold Remediation Chemicals, Termiticides/Insecticides
For hired contractors & do-it-yourselfers	
Corrosion Inhibitors, Glycol-based antifreezes, Solder Flux, Thread Sealants Flexible Cable/Wiring (especially communications cabling) Caulks/Mastics, Adhesive, Vinyl/Electrical Tape Non-Approved Spray Foam Insulation Non-Water Based Paint, Paint Thinners Wood Finishes / Varnishes	

The following jobsite activities or conditions should be avoided:

- Sitting, standing, hanging, leaning, or resting anything on the pipe, fittings, and sprinklers
- Grounding electrical wiring to the pipe or fittings
- Ambient temperatures below 40°F (4,4°C) where your fire sprinkler system is located. (Unless an approved compatible antifreeze or insulation method is installed.)
- Hot work around the pipe, for example, blow torches, soldering, etc.

Be certain that this document is reviewed and understood by anyone working on or around your CPVC life safety system. If you have any questions or need assistance on chemical compatibility with your IPEX CPVC fire sprinkler system, contact the manufacturer of the chemical or non-CPVC product in question.

Proper care will help your IPEX CPVC fire sprinkler system provide protection for years to come.

SALES AND CUSTOMER SERVICE

Customers call IPEX USA LLC.

Toll free: (800) 463-9572

www.ipexna.com

About IPEX by Aliaxis

As leading suppliers of thermoplastic piping systems, IPEX by Aliaxis provides our customers with some of the world's largest and most comprehensive product lines. All IPEX by Aliaxis products are backed by more than 50 years of experience. With state-of-the-art manufacturing facilities and distribution centers across North America, we have earned a reputation for product innovation, quality, end-user focus and performance.

Markets served by IPEX by Aliaxis products are :

- Electrical systems
- Telecommunications and utility piping systems
- PVC, CPVC, PP, PVDF, PE, ABS, and PEX pipe and fittings
- Industrial process piping systems
- Municipal pressure and gravity piping systems
- Plumbing and mechanical piping systems
- Electrofusion systems for gas and water
- Industrial, plumbing and electrical cements
- Irrigation systems

BlazeMaster® is manufactured by IPEX USA LLC. and distributed in Canada by IPEX Inc.
BlazeMaster® is a registered trademark of the Lubrizol Corporation.

www.ipexna.com

This literature is published in good faith and is believed to be reliable. However, it does not represent and/or warrant in any manner the information and suggestions contained in this brochure. Data presented is the result of laboratory tests and field experience. A policy of ongoing product improvement is maintained. This may result in modifications of features and/or specifications without notice